



Price Catalogue | 2023-24

Laboratory Glassware & Essentials

Effective from 20th May 2023



**NEW
LAUNCH**

QR-Coded Volumetric Glassware

Now calibration certificate is only 1 step away!

*Scan & Download
Calibration Certification*



Products Available

- Burettes
- Volumetric Flasks
- Measuring Cylinders





Shiv Dial Sud & Sons Corporate Profile



Founded in 1943, **SHIV DIAL SUD & SONS** is universally recognized as a leading and reliable Manufacturer and Exporter of Laboratory Glassware, Plasticware, Lab Equipment, Instruments & Filter Papers for use in Education, Research, Health-care & Industry. We export to more than Eighty countries across all continents and have been awarded by Government of India for our outstanding exports on a number of occasions.

Our commitment to provide highest precision products has resulted in our brand "**supertek**" becoming synonymous with Reliability, Trust & Quality – values that also characterize our corporate philosophy. Our management consists of Engineers and Scientists, having combined experience exceeding 80 years and a team dedicated to produce high quality products with latest technologies. Our prices remain highly competitive, thus allowing our customers to manage their budgets efficiently. We do provide customized solutions as per client's specific requirements as well.

With five manufacturing units spread over an area of more than 100,000 sq. ft and a well-trained highly skilled work force, delivering quality products is our priority. Our infrastructure consists of latest CNC's & VMC's, Automats and conventional machinery for standardized production. Our product range includes Teaching Aids, Laboratory Glassware and Laboratory Essentials. Well scripted business processes, periodic inspections and audits and single-minded focus of Quality, makes our products the right choice for our customers across the world. This catalogue contains our Laboratory Glassware, Lab Equipment, Filter Paper, Plasticware & Lab Essentials product range. Catalogues for Physics, Chemistry and other Lab supplies are available separately.

"**supertek**" ventured into fabrication of laboratory glassware with a vision to provide superior quality glassware at the right prices. Our products are made according to International Standards such as ISO, DIN & ASTM and are manufactured in our state-of-the-art plant by highly skilled work force. A 20,000 sq. ft facility houses latest machinery for fabrication of Laboratory Glassware, Automatic Volumetric Calibration Units to guarantee highest precision, Lehr Conveyer Furnace to ensure proper annealing, Precision Equipment to test Glass Strain, Automatic Test Tube making machine to provide consistent quality, Printing Machines for clear & long-lasting printing on glassware and many semi-automatic glass blowing machines for mass production.

Every "**supertek**" product undergoes several Quality Checks and is packed and shipped with utmost care. Our large Warehouse allows us to maintain adequate inventory of raw and finished goods and enables us to meet your requirements in shortest possible lead time. In addition, our Distributor Network across the country ensures consistent availability of our products near to you.

"**supertek**" is committed to deliver High Quality Products, at competitive prices-always!

Director's Message

“ We are pleased to present the 10th Edition of our Domestic Catalogue. It is an honor for us to be a part of the Scientific Industry and help scientists and researchers to accomplish their goals. We are constantly improving our services and products to ensure that our customers receive the best quality. We are thankful to our customers for choosing **supertek**®. In order to provide high-quality products, we continue to improve our work processes. We are expanding our range to launch new products for the benefit of our customers. QR-coded Glassware, Plasticware, and some Equipment are our new introductions, which you can look for in this Catalogue.

Your suggestions and inputs will help us to improve further and we look forward to receiving these in days to come.

We wish you a prosperous and successful year ahead.

”

Alok Sood

Director - sales

Our Presence

Serving 80 countries Worldwide



Achievements



2013



2014



2015



2016



2016

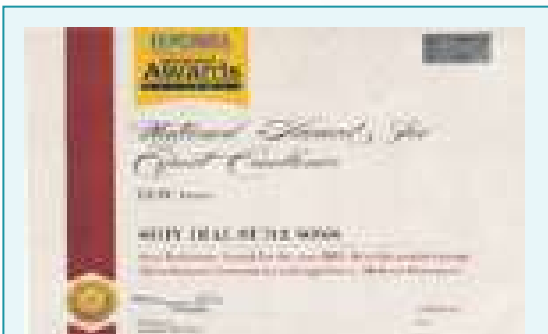

2017



2021

We offer our customers a wide range of Laboratory Glassware. Our product range includes Volumetric Glassware, Inter-changeable Glassware, Condensers, General Labware, Glass Filtration Assembly, Glass Bottles and Tubes. We can also provide customized products depending upon customer requirement.

Glassware Unit



Manufacturing Infrastructure



Team of dedicated engineers guide skilled glass blowers working on Automatic & Semi-automatic machines to manufacture glassware products of different shapes and sizes as per International standards



Standardized products are produced using Low expansion Boro 3.3 Glass as per ISO 3585 and ASTM E-438 TYPE 1 CLASS A. The raw material is sourced from reputed suppliers all over the world. We are sufficiently stocked with raw material at any given time.



All products manufactured by supertek® are annealed in Lehr conveyor furnace for producing strain free final products. Products are heated to precise annealing temperature and slowly cooled for a predefined period to ensure removal of all kinds of thermal stress and minimize chances of physical damage with change in temperature or mechanical shock.



Ultrasonic washing machines are employed to ensure clean & clear products.



Delivering High volume products on time requires specialized equipment. Automatic printing machines are employed to handle production quantity of products with huge volume.

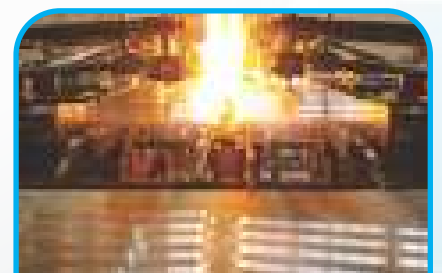

Automatic production machines are employed to handle large volume of Test tubes ensuring uniform wall thickness and strong rim.

Volumetric Calibration

supertek® brand volumetric products are precisely calibrated in controlled environment on state of the art Automatic Calibrated Machines and highly accurate Balances. These machines are tuned to deliver products with highest possible accuracy. These machines work with temperature control equipment to regulate changes in calibration with change in water temperature. Lasers are used to check water meniscus and marking is done with diamond tools requiring no human intervention.



ISO 17025:2017 Certificate

supertek[®] Calibration Laboratory has undertaken accreditation for calibration and testing as per ISO 17025:2017 from National Accreditation Board for testing and calibration Laboratory (NABL), which is an autonomous body under aegis of Department of Science & Technology, Government of India. NABL has a mutual recognition arrangement under the Asia Pacific Laboratory Accreditation Cooperation (APLAC) and the International Laboratory Accreditation Cooperation (ILAC), which means the calibrated product provided to customers approved by NABL is acceptable in calibration laboratories worldwide.

		National Accreditation Board for Testing and Calibration Laboratories	
CERTIFICATE OF ACCREDITATION			
SUPERTEK CALIBRATION LABORATORY			
has been assessed and accredited in accordance with the standard			
ISO/IEC 17025:2017			
"General Requirements for the Competence of Testing & Calibration Laboratories"			
for its facilities at			
333, INDUSTRIAL GROWTH CENTER, SAHA, AMBALA, HARYANA, INDIA			
in the field of			
CALIBRATION			
Certificate Number:	CC-2868		
Issue Date:	10/10/2022	Valid Until:	09/10/2024
This certificate remains valid for the Scope of Accreditation as specified in the annexure subject to continued satisfactory compliance to the above standard & the relevant requirements of NABL. (To see the scope of accreditation of this laboratory, you may also visit NABL website www.nabl-india.org)			
Name of Legal Identity : SUPERTEK CALIBRATION LABORATORY			
Signed for and on behalf of NABL			
	 N. Venkateswaran Chief Executive Officer		

Quality Assurance

Product quality directly depends on the quality of process. Quality control for **supertek**[®] products is employed in each stage of manufacturing process. This holistic view of quality assurance, involving all aspects of design, production, testing and packing ensures conformity with internal specifications as well as international standards. This is reflected in the approvals of ISO9001:2008 & ISO17025 standard.



Quality Checks



Enamel Adhesion Check

Tests are carried out as per ISO 4794 to ensure that enamel does not rub-off even with repeated usage and stays consistent even after using in Laboratory Glassware washers.

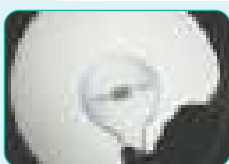

Optical Clarity Check

Optical clarity of all the products manufactured is checked to ensure only clear glass products are supplied to all our users.

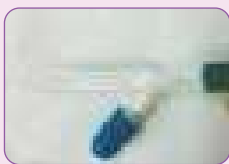

Leakage Check

All Stopcocks are checked for any form of leakage first individually and then post attachment to make sure that no apparatus supplied by **Supertek** leaks.

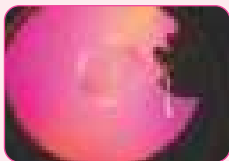

Residual Strain Check

Strain checking equipment (Polariscope) from one of the best manufacturer is used by Supertek to check for any residual strain in the products.

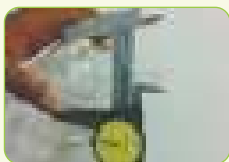

Dimensional Check

Measuring Instruments of high accuracy are used for inspection of each and every piece atleast TWICE!!

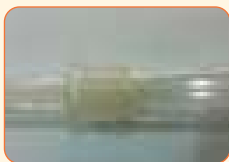

Joint Fitting Check

Dimensions and fitting of all sockets & cones are checked for proper taper ensuring zero leakage on use.

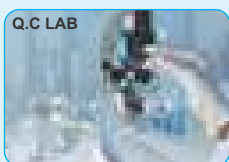

Calibration check

All Volumetric glassware are checked at our ISO 17025 certified Calibration Lab for accuracy

ISO 9001:2015 Certificate



This is to certify that the management system of:

SHIV DIAL SUD & SONS

has been registered by Intertek as conforming to the requirements of:

ISO 9001:2015

Scope of the certification:

Design, Manufacture & Distribution of Scientific Instruments, Laboratory Equipment, Laboratory Glassware and Plastic ware.

The certification covers:

Central Function: Main Site: Head office: 23, Industrial Estate, Jagadhri Road, Ambala Cantt, Haryana, 133 006, India

Scope: Design, Manufacture & Distribution of Scientific Instruments, Laboratory Equipment, Laboratory Glassware and Plastic ware.

Name of site # 1: Site 1: Plot no. 54, Industrial area, Jagadhri Road, Ambala Cantt, Haryana, India

Scope: Manufacturing of Laboratory Equipment and Microscopes.

Name of site # 2: Plot No. 88-89, Industrial area, Jagadhri Road, Ambala Cantt, Haryana, India

Scope: Design and Manufacturing of Scientific Instruments and Laboratory Equipment.

Name of site # 3: Plot No. 333, HSIIDC Industrial Growth Centre, Saha, Distt. Ambala Cantt, Haryana, India

Scope: Manufacturing of Laboratory Glassware.

Certificate Number:

0099257

Initial Certification Date:

26 February 2020

Date of Certification Decision:

15 February 2023

Issuing Date:

15 February 2023

Valid Until:

25 February 2026



intertek



014

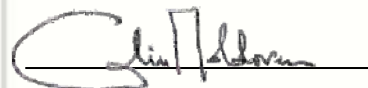

Calin Moldovean

President, Business Assurance

Intertek Certification Limited, 10A Victory Park,
Victory Road, Derby DE24 8ZF, United Kingdom



Intertek Certification Limited is a UKAS accredited body under schedule of accreditation no. 014.

In the issuance of this certificate, Intertek assumes no liability to any party other than to the Client, and then only in accordance with the agreed upon Certification Agreement. This certificate's validity is subject to the organisation maintaining their system in accordance with Intertek's requirements for systems certification. Validity may be confirmed via email at certificate.validation@intertek.com or by scanning the code to the right with a smartphone. The certificate remains the property of Intertek, to whom it must be returned upon request.

CT-ISO 9001:2015-UKAS-EN-A4-P-2,jul.21



Volumetric Glassware

supertek® brand volumetric products are precisely calibrated in controlled environment to get very accurate determination and measurement of volumes. supertek® products are available in both class A and class B, calibrated on state of the art Automatic Calibration Machines.

supertek® Calibration Laboratory has undertaken accreditation for calibration and testing as per ISO 17025:2017 from National Accreditation Board for testing and calibration Laboratory (NABL), which is a autonomous body under aegis of Department of Science & Technology, Government of India. NABL has a mutual recognition arrangement under the Asia Pacific Laboratory Accreditation Cooperation (APLAC) and the International Laboratory Accreditation Cooperation (ILAC), which means the calibrated product provided to customers approved by NABL is acceptable in calibration laboratories worldwide.

  National Accreditation Board for Testing and Calibration Laboratories			
CERTIFICATE OF ACCREDITATION			
SUPERTEK CALIBRATION LABORATORY			
has been assessed and accredited in accordance with the standard			
ISO/IEC 17025:2017			
"General Requirements for the Competence of Testing & Calibration Laboratories"			
for its facilities at			
333, INDUSTRIAL GROWTH CENTER, SAHA, AMBALA, HARYANA, INDIA			
in the field of			
CALIBRATION			
Certificate Number:	CC-2868	Valid Until:	09/10/2024
Issue Date:	10/10/2022		
This certificate remains valid for the Scope of Accreditation as specified in the annexure subject to continued satisfactory compliance to the above standard & the relevant requirements of NABL. (To see the scope of accreditation of this laboratory, you may also visit NABL website www.nabl-india.org)			
Name of Legal Identity : SUPERTEK CALIBRATION LABORATORY			
Signed for and on behalf of NABL			
	 N. Venkateswaran Chief Executive Officer		

Supertek products are available with following certificates

Class A Individual Certificate

Individual certificate is given with the product. Certified volume of the product and environmental conditions during calibration of the product are mentioned on the same. Each product is printed with Individual no. and certificate for same is provided with the product.

NABL Approved Class A Individual Certificate

Individual certificate which have been approved by NABL Certified Laboratory. Each product is printed with Individual no. and certificate for same is provided with the product.



Certificate No.
C-1108

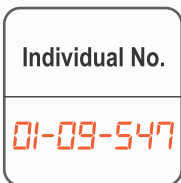

A unique serial number (e.g. 11-22-33) is mentioned on the unit. Certificate can be downloaded from our app "Supertek" available on Android & IOS or from www.supertekglassware.com



IOS

SCAN
QR CODE:



Android

SCAN
QR CODE:

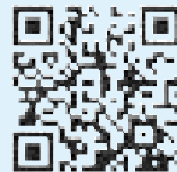

Website

Technical Data

supertek® Laboratory Glassware is made of Heat Resistant Borosilicate 3.3 Glass, unless otherwise specified. It is suitable for use in laboratories as well as industrial application.

CHEMICAL COMPOSITION

	Approx % by weight
SiO ₂	81
B ₂ O ₃	13
Na ₂ O/(K ₂ O)	4
Al ₂ O ₃	2

THERMAL PROPERTIES

The typical thermal properties of supertek glassware are given below:

Coefficient of Linear Expansion	32.5 x 10 ⁻⁷ /°C
Strain Point	515°C
Annealing Point	565°C
Softening Point	820°C
Specific Heat	0.2
Thermal Conductivity (Cal/cm ³ °C/sec)	0.0027

CHEMICAL DURABILITY

Glassware is resistant to water, neutral and acid solutions, concentrated acids and their mixtures as well as to chlorine, bromine, iodine and organic matters. Only hydrofluoric acid, very hot phosphoric acid and alkaline solutions increasingly attack the glass surface with rising concentration and temperature.

LABORATORY GLASSWARE & ESSENTIALS

Glassware

- Volumetric Glassware	01-36
- Interchangeable	37-56
- Condensers, Column	57-68
- General Labware	69-101
- Sintered Glassware Filtration	102-109
- Bottle & Distillation Apparatus	110-129
- Tubes, Quartzware & Porcelain & Silicaware	130-140
- Distillation Stills	141-143

Glasswar - 01-143

Essentials

- Filter Papers	145-146
- Laboratory Jacks, Clamps, Tripod Stands	147-152
- Tongs, Retort Stands, Spatulas, Test Tube Stands	153-157
- Burners, Rubberware	158-166
- Brushes	167-168
- Surgical Mask	169
- Syringe Filters, Membrane Filters	170-173

Essentials - 145-173

Equipment

- Heating Mantles	175-178
- Laboratory Hot Plate	178-181
- Magnetic Stirrer	182
- Vortex Mixer, Digital Autoclave	183
- Incubator & Triple Water Bath	184
- Water Bath Digital & Ultrasonic Bath	185
- Oven, UV Cabinet & UV Sanitization	186-187

Equipment - 175-187

Plasticware

- Beakers & Reagent Bottles	189-192
- Wash Bottle & Conical Flask	192
- Burette, Flask Support	193
- Cylinder & Volumetric Flask	193-195
- Funnel, Separating Funnel & Holder	196-197
- Pasteur Pipettes & Pipettes Stands	197-198
- Tray, Test Tube Baskets & Stand	199-200
- Container, Stool, Microscope Slide Box	201

Plasticware - 189-201

Volumetric Glassware



**Looking for Precision Results ?
Look for Supertek high quality Volumetricware !**

QR - CODED Volumetric Glassware

A smart way to access calibration certificate



Scan QR-Code

Features & Benefits of using a QR Coded Volumetric Glassware

Laser
Engraved
QR Code

Permanently
inscribed

Certificate
available in
seconds

Audit
Ready,
Always

User
Friendly



- **Burettes**
- **Measuring Cylinders**
- **Volumetric Flasks**

For more details you can share your enquiry for QR Coded Volumetric Glassware to our Sales Representative or send a mail to :

✉ support@supertekglassware.com, ✉ technical@supertekglassware.com

NABL Certified Volumetric Glassware

supertek® offers premium range of NABL Certified Volumetric Glassware. These are critical standardize for your laboratory requirement and audit processes.



We Offers:

- Burettes
- Pipettes
- Volumetric Flasks
- Measuring Cylinders



"supertek® calibration process and laboratory accredited by National Accreditation Board for Testing and Calibration Laboratories."

For more details you can share your enquiry for NABL Certified Volumetric Glassware to our [Area Sales Manager](#) or mail your request to support@supertekglassware.com, technical@supertekglassware.com

Burettes

Wide Range for Critical and Routine Titration

supertek® Burettes are manufactured from low expansion 3.3 Borosilicate glass. A burette is a volumetric measuring glassware which is used in analytical chemistry for accurate dispensing of a liquid. Burette is an essential laboratory apparatus, commonly used in the titration process for quantitative analysis in many industrial chemical tests, where solutions of known concentration are used to find the concentration of unknown solution.

supertek® Burettes come with 4 different types of stopcocks

Glass Key



Glass Screw Cap



PTFE Needle (Rotaflow)



PTFE Key



	 supertek®	← Supertek Brand
ISO Standard →	ISO/385	
Capacity →	50:0.1	← Sub Division
	A	← Class
To Deliver →	Ex	
	27°C	← Calibration Temp.
Tolerance →	±0.05 ml	
	02.22	← Batch No
Individual No →	1020	



<i>Our Printing Criteria</i>	
ISO Class A	White printing
ISO Class B	White printing
Amber Glass	White printing

Special features of supertek® certified glassware

- Conforming international specification ISO and ASTM
- Individually calibrated and certified (A class only)
 - Multiple sizes & grades
 - Complete traceability

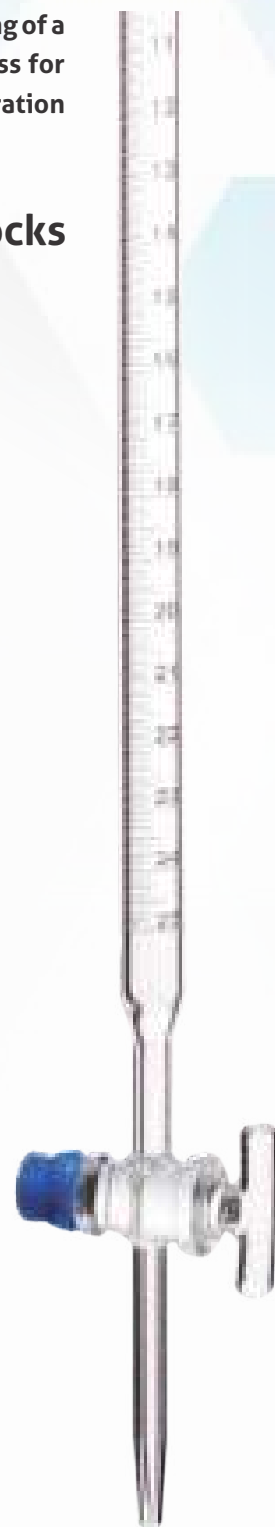

Right mix of quality and efficiency

Burette, With Glass Screw Cap Stopcock, Class A With Individual Works Certificate

- Calibrated at 27°C
- The volume content tolerances conform to Class A of ISO 385 / IS 1997
- Generally used in Titration process
- Designed with straight bore stopcock that increases the life, compared to PTFE key stopcocks
- The glass stopcock enhances control and enables smoother action
- A calibration certificate is provided with each Individual certified unit & same is available on our website

Cat No.	Capacity ml	Sub-div. ml	Tolerance \pm ml	Pack Size
77.101.0001	1**	0.01	0.006	4
77.101.0002	2**	0.01	0.01	4
77.101.0005	5**	0.02	0.01	4
77.101.0010	10	0.05	0.03	4
77.101.0025	25	0.1	0.05	4
77.101.0050	50	0.1	0.05	4
77.101.0100	100	0.2	0.1	4

** with cup top

Burette, With Glass Screw Cap Stopcock Class A With NABL Certificate

- Calibrated at 27°C
- The volume content tolerances conform to Class A of ISO 385 / IS 1997
- Generally used in Titration process
- Designed with straight bore stopcock that increases the life, compared to PTFE key stopcocks
- The glass stopcock enhances control and enables smoother action
- NABL Certificate is supplied with each unit



Cat No.	Capacity, ml	Sub-div. ml	Tolerance, \pm ml	Pack Size
72.101.0010	10	0.05	0.03	1
72.101.0025	25	0.1	0.05	1
72.101.0050	50	0.1	0.05	1
72.101.0100	100	0.2	0.1	1



Burette, With Glass Screw Cap Stopcock, Class B

- Calibrated at 27°C
- The volume content tolerances conform to Class B of ISO 385 / IS 1997
- Generally used in Titration process
- Designed with straight bore stopcock that increases the life, compared to PTFE key stopcocks
- The glass stopcock enhances control and enables smoother action

Cat No.	Capacity ml	Sub-div. ml	Tolerance \pm ml	Pack Size
70.101.0010	10	0.05	0.05	4
70.101.0025	25	0.1	0.1	4
70.101.0050	50	0.1	0.1	4
70.101.0100	100	0.2	0.2	4



Burette, With Screw Type PTFE Needle Valve (Rotaflo) Stopcock, Class A With Individual Works Certificate

- Calibrated at 27°C
- The volume content tolerances conform to Class A of ISO 385 / IS 1997
- Generally used in Titration process
- Supplied with Rotaflo with PTFE Needle Valve that is highly resistant to chemical attack
- No need to lubricate it as PTFE Needle Valve is used
- A calibration certificate is provided with each Individual certified unit & same is available on our website

Cat No.	Capacity ml	Sub-div. ml	Tolerance ± ml	Pack Size
77.103.0001	1**	0.01	0.006	4
77.103.0002	2**	0.01	0.01	4
77.103.0005	5**	0.02	0.01	4
77.103.0010	10	0.05	0.03	4
77.103.0025	25	0.1	0.05	4
77.103.0050	50	0.1	0.05	4
77.103.0100	100	0.2	0.1	4

** with cup top

Burette, With Screw Type PTFE Needle Valve (Rotaflo) Stopcock, Class A With NABL Certificate

- Calibrated at 27°C
- The volume content tolerances conform to Class A of ISO 385 / IS 1997
- Generally used in Titration process
- Supplied with Rotaflo with PTFE Needle Valve that is highly resistant to chemical attack
- No need to lubricate it as PTFE Needle Valve is used
- NABL Certificate is supplied with each unit



Cat No.	Capacity, ml	Sub-div. ml	Tolerance, ± ml	Pack Size
72.103.0010	10	0.05	0.03	1
72.103.0025	25	0.1	0.05	1
72.103.0050	50	0.1	0.05	1
72.103.0100	100	0.2	0.1	1

Burette, With Screw Type PTFE Needle Valve (Rotaflo) Stopcock, Class B

- Calibrated at 27°C
- The volume content tolerances conform to Class B of ISO 385 / IS 1997
- Generally used in Titration process
- Supplied with Rotaflo with PTFE Needle Valve that is highly resistant to chemical attack
- No need to lubricate it as PTFE Needle Valve is used

Cat No.	Capacity ml	Sub-div. ml	Tolerance ± ml	Pack Size
70.103.0010	10	0.05	0.05	4
70.103.0025	25	0.1	0.1	4
70.103.0050	50	0.1	0.1	4
70.103.0100	100	0.2	0.2	4

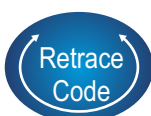

Amber Color Burette, With Screw Type PTFE Needle Valve (Rotaflow) Stopcock, Class A With Individual Works Certificate

- Calibrated at 27°C
- The volume content tolerances conform to Class A of ISO 385 / IS 1997
- Generally used in Titration process
- Supplied with Rotaflow with PTFE Needle Valve that is highly resistant to chemical attack
- No need to lubricate it as PTFE Needle Valve is used
- Amber color is applied to reduce UV light penetration
- A calibration certificate is provided with each Individual certified unit & same is available on our website

Cat No.	Capacity ml	Sub-div. ml	Tolerance \pm ml	Pack Size
75.103.0025	25	0.1	0.05	1
75.103.0050	50	0.1	0.05	1

Amber Color Burette, With Screw Type PTFE Needle Valve (Rotaflow) Stopcock, Class A With NABL Certificate

- Calibrated at 27°C
- The volume content tolerances conform to Class A of ISO 385 / IS 1997
- Generally used in Titration process
- Supplied with Rotaflow with PTFE Needle Valve that is highly resistant to chemical attack
- No need to lubricate it as PTFE Needle Valve is used
- Amber color is applied to reduce UV light penetration
- NABL Certificate is supplied with each unit



Cat No.	Capacity, ml	Sub-div. ml	Tolerance, \pm ml	Pack Size
73.103.0025	25	0.1	0.05	1
73.103.0050	50	0.1	0.05	1

Amber Color Burette, With Screw Type PTFE Needle Valve (Rotaflow) Stopcock, Class B

- Calibrated at 27°C
- The volume content tolerances conform to Class B of ISO 385 / IS 1997
- Generally used in Titration process
- Supplied with Rotaflow with PTFE Needle Valve that is highly resistant to chemical attack
- No need to lubricate it as PTFE Needle Valve is used
- Amber color is applied to reduce UV light penetration

Cat No.	Capacity ml	Sub-div. ml	Tolerance \pm ml	Pack Size
71.103.0010	10	0.05	0.05	1
71.103.0025	25	0.1	0.1	1
71.103.0050	50	0.1	0.1	1

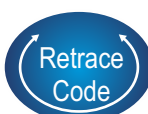

Burette, With Straight Bore PTFE Key Stopcock, Class A With Individual Works Certificate

- Calibrated at 27°C
- The volume content tolerances conform to Class A of ISO 385 / IS 1997
- Generally used in Titration process
- Comes with PTFE key that is highly resistant to chemical attack
- No need to lubricant it as PTFE key is used
- A calibration certificate is provided with each Individual certified unit & same is available on our website

Cat No.	Capacity ml	Sub-div. ml	Tolerance \pm ml	Pack Size
77.102.0001	1**	0.01	0.006	4
77.102.0002	2**	0.01	0.01	4
77.102.0005	5**	0.02	0.01	4
77.102.0010	10	0.05	0.03	4
77.102.0025	25	0.1	0.05	4
77.102.0050	50	0.1	0.05	4
77.102.0100	100	0.2	0.1	4

** with cup top

Burette, With Straight Bore PTFE Key Stopcock, Class A With NABL Certificate

- Calibrated at 27°C
- The volume content tolerances conform to Class A of ISO 385 / IS 1997
- Generally used in Titration process
- Comes with PTFE key that is highly resistant to chemical attack
- No need to lubricant it as PTFE key is used
- NABL Certificate is supplied with each unit



Cat No.	Capacity, ml	Sub-div. ml	Tolerance, \pm ml	Pack Size
72.102.0010	10	0.05	0.03	1
72.102.0025	25	0.1	0.05	1
72.102.0050	50	0.1	0.05	1
72.102.0100	100	0.2	0.1	1

Burette, With Straight Bore PTFE Key Stopcock, Class B

- Calibrated at 27°C
- The volume content tolerances conform to Class B of ISO 385 / IS 1997
- Generally used in Titration process
- Comes with PTFE key that is highly resistant to chemical attack
- No need to lubricant it as PTFE key is used

Cat No.	Capacity ml	Sub-div. ml	Tolerance \pm ml	Pack Size
70.102.0010	10	0.05	0.05	4
70.102.0025	25	0.1	0.1	4
70.102.0050	50	0.1	0.1	4
70.102.0100	100	0.2	0.2	4

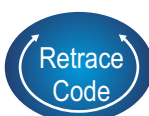
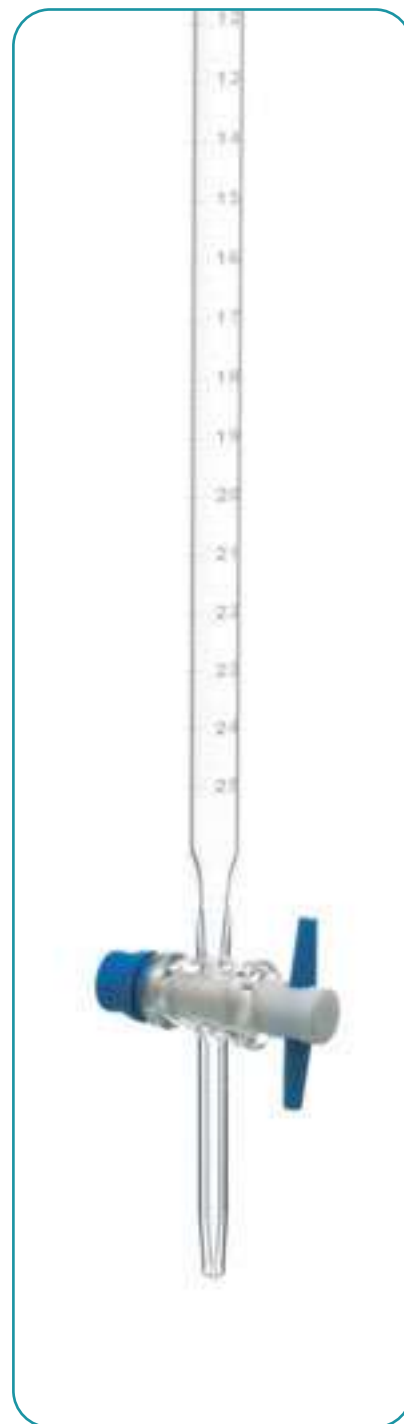

Amber Color Burette, With Straight Bore PTFE Key Stopcock, Class A With Individual Works Certificate

- Calibrated at 27°C
- The volume content tolerances conform to Class A of ISO 385 / IS 1997
- Generally used in Titration process
- Comes with PTFE key that is highly resistant to chemical attack
- No need to lubricant it as PTFE key is used
- Amber color is applied to reduce UV light penetration
- A calibration certificate is provided with each Individual certified unit & same is available on our website

Cat No.	Capacity ml	Sub-div. ml	Tolerance \pm ml	Pack Size
75.102.0010	10	0.05	0.03	1
75.102.0025	25	0.1	0.05	1
75.102.0050	50	0.1	0.05	1
75.102.0100	100	0.2	0.1	1



Burette, With Straight Bore Glass Key Stopcock, Class B

- Calibrated at 27°C
- The volume content tolerances conform to Class B of ISO 385/ IS 1997
- Generally used in Titration process

Cat No.	Capacity ml	Sub-div. ml	Tolerance \pm ml	Pack Size
70.105.0010	10	0.05	0.05	4
70.105.0025	25	0.1	0.1	4
70.105.0050	50	0.1	0.1	4
70.105.0100	100	0.2	0.2	4

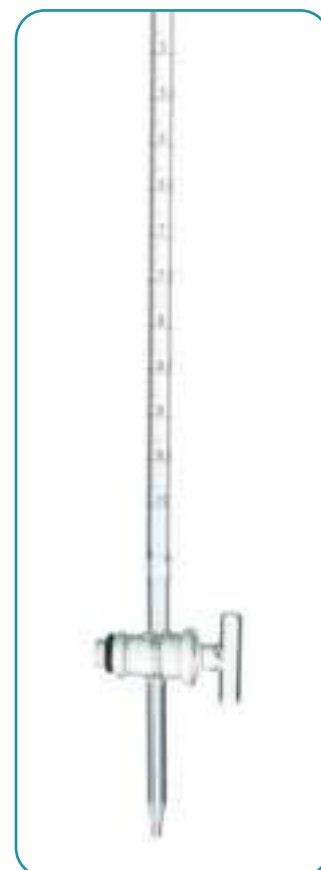

 Precision Bore

 Retrace Code

 ISO 385
IS 1997

Burettes, Automatic Zero, Mounted on Reservoir, Rubber Bellow, Accuracy as per Class 'A' of IS 1997 : 2008, With Individual Works Certificate

- Calibrated at 27°C
- The volume content tolerances conform to Class A of ISO 385 / IS 1997
- With automatic zero facility
- A calibration certificate is provided with each Individual certified unit & same is available on our website

Cat No.	Stopcock	Capacity ml	Sub-div. ml	Tolerance ± ml	Bottle Capacity ml	Pack Size
77.114.0010	Glass Screw Cap	10	0.05	0.03	500	1
77.114.0025	Glass Screw Cap	25	0.1	0.05	2000	1
77.114.0050	Glass Screw Cap	50	0.1	0.05	2000	1
77.114.0100	Glass Screw Cap	100	0.2	0.1	2000	1
77.108.0010	PTFE Needle Valve (Rotaflo)	10	0.05	0.03	500	1
77.108.0025	PTFE Needle Valve (Rotaflo)	25	0.1	0.05	2000	1
77.108.0050	PTFE Needle Valve (Rotaflo)	50	0.1	0.05	2000	1
77.108.0100	PTFE Needle Valve (Rotaflo)	100	0.2	0.1	2000	1
77.110.0010	PTFE Key	10	0.05	0.03	500	1
77.110.0025	PTFE Key	25	0.1	0.05	2000	1
77.110.0050	PTFE Key	50	0.1	0.05	2000	1
77.110.0100	PTFE Key	100	0.2	0.1	2000	1

Burettes, Automatic Zero, Mounted on Reservoir, Rubber Bellow, Accuracy as per Class 'A' of IS 1997 : 2008, With NABLCertificate

- Calibrated at 27°C
- The volume content tolerances conform to Class A of ISO 385 / IS 1997
- With automatic zero facility
- NABL Certificate is supplied with each unit



Cat No.	Stopcock	Capacity ml	Sub-div. ml	Tolerance ± ml	Bottle Capacity ml	Pack Size
72.114.0025	Glass Screw Cap	25	0.1	0.05	2000	1
72.114.0050	Glass Screw Cap	50	0.1	0.05	2000	1
72.108.0025	PTFE Needle Valve (Rotaflo)	25	0.1	0.05	2000	1
72.108.0050	PTFE Needle Valve (Rotaflo)	50	0.1	0.05	2000	1

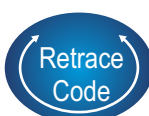

Amber Color Burettes, Automatic Zero, Mounted on Reservoir, Rubber Bellow, Accuracy as per Class 'A' of IS 1997 : 2008, With Individual Works Certificate

- Calibrated at 27°C
- The volume content tolerances conform to Class A of ISO 385 / IS 1997
- With automatic zero facility
- Amber color is applied to reduce UV light penetration
- A calibration certificate is provided with each Individual certified unit & same is available on our website

Cat No.	Stopcock	Capacity ml	Sub-div. ml	Tolerance \pm ml	Bottle Capacity ml	Pack Size
75.114.0010	Glass Screw Cap	10	0.05	0.03	500	1
75.114.0025	Glass Screw Cap	25	0.1	0.05	2000	1
75.114.0050	Glass Screw Cap	50	0.1	0.05	2000	1
75.114.0100	Glass Screw Cap	100	0.2	0.1	2000	1
75.108.0010	PTFE Needle Valve (Rotafllo)	10	0.05	0.03	500	1
75.108.0025	PTFE Needle Valve (Rotafllo)	25	0.1	0.05	2000	1
75.108.0050	PTFE Needle Valve (Rotafllo)	50	0.1	0.05	2000	1
75.108.0100	PTFE Needle Valve (Rotafllo)	100	0.2	0.1	2000	1
75.110.0010	PTFE Key	10	0.05	0.03	500	1
75.110.0025	PTFE Key	25	0.1	0.05	2000	1
75.110.0050	PTFE Key	50	0.1	0.05	2000	1
75.110.0100	PTFE Key	100	0.2	0.1	2000	1

Amber Color Burettes, Automatic Zero, Mounted on Reservoir, Rubber Bellow, Accuracy as per Class 'A' of IS 1997 : 2008, With NABL Certificate

- Calibrated at 27°C
- The volume content tolerances conform to Class A of ISO 385 / IS 1997
- With automatic zero facility
- Amber color is applied to reduce UV light penetration
- NABL Certificate is supplied with each unit



Cat No.	Stopcock	Capacity ml	Sub-div. ml	Tolerance \pm ml	Bottle Capacity ml	Pack Size
73.114.0025	Glass Screw Cap	25	0.1	0.05	2000	1
73.114.0050	Glass Screw Cap	50	0.1	0.05	2000	1
73.108.0025	PTFE Needle Valve (Rotafllo)	25	0.1	0.05	2000	1
73.108.0050	PTFE Needle Valve (Rotafllo)	50	0.1	0.05	2000	1



Precision
Bore

Retrace
Code

ISO 385
IS 1997

Burettes, Automatic Zero, Mounted on Reservoir, Rubber Bellow, Accuracy as per Class 'B' of IS 1997 : 2008.

- Calibrated at 27°C
- The volume content tolerances conform to Class B of ISO 385 / IS 1997
- With automatic zero facility

Cat No.	Stopcock	Capacity ml	Sub-div. ml	Tolerance ± ml	Bottle Capacity ml	Pack Size
70.114.0010	Glass Screw Cap	10	0.05	0.05	500	1
70.114.0025	Glass Screw Cap	25	0.1	0.1	2000	1
70.114.0050	Glass Screw Cap	50	0.1	0.1	2000	1
70.114.0100	Glass Screw Cap	100	0.2	0.2	2000	1
70.108.0010	PTFE Needle Valve (Rotaflo)	10	0.05	0.05	500	1
70.108.0025	PTFE Needle Valve (Rotaflo)	25	0.1	0.1	2000	1
70.108.0050	PTFE Needle Valve (Rotaflo)	50	0.1	0.1	2000	1
70.108.0100	PTFE Needle Valve (Rotaflo)	100	0.2	0.2	2000	1
70.110.0010	PTFE Key	10	0.05	0.05	500	1
70.110.0025	PTFE Key	25	0.1	0.1	2000	1
70.110.0050	PTFE Key	50	0.1	0.1	2000	1
70.110.0100	PTFE Key	100	0.2	0.2	2000	1

Amber Color Burettes, Automatic Zero, Mounted on Reservoir, Rubber Bellow, Accuracy as per Class 'B' of IS 1997 : 2008

- Calibrated at 27°C
- The volume content tolerances conform to Class B of ISO 385 / IS 1997
- With automatic zero facility
- Amber color is applied to reduce UV light penetration

Cat No.	Stopcock	Capacity ml	Sub-div. ml	Tolerance ± ml	Bottle Capacity ml	Pack Size
71.114.0010	Glass Screw Cap	10	0.05	0.05	500	1
71.114.0025	Glass Screw Cap	25	0.1	0.1	2000	1
71.114.0050	Glass Screw Cap	50	0.1	0.1	2000	1
71.114.0100	Glass Screw Cap	100	0.2	0.2	2000	1



Spare Rubber Bellow With Cotton Net for Automatic Burettes

Cat No.	Pack Size
77.108.1111	2

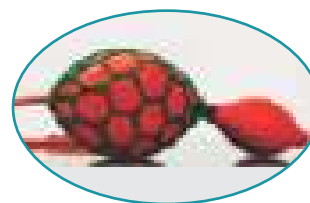

Pipettes

Playing a Key Role in Every Laboratory

Pipettes are widely used to transfer and dispense fixed amounts of liquids. **supertek**[®] Pipettes come in many different varieties and each variety is targeted to specific use in the Laboratory. Two of the most common types of pipettes are Volumetric and Graduated pipettes, both of which can be found in most laboratories and research facilities. However, there are significant differences in them and each type of pipette is built with distinct advantages and disadvantages making it essential to understand the functions of each one before use. Each product is color coded to facilitate easy identification.

Understanding the marking of Volumetric Pipettes

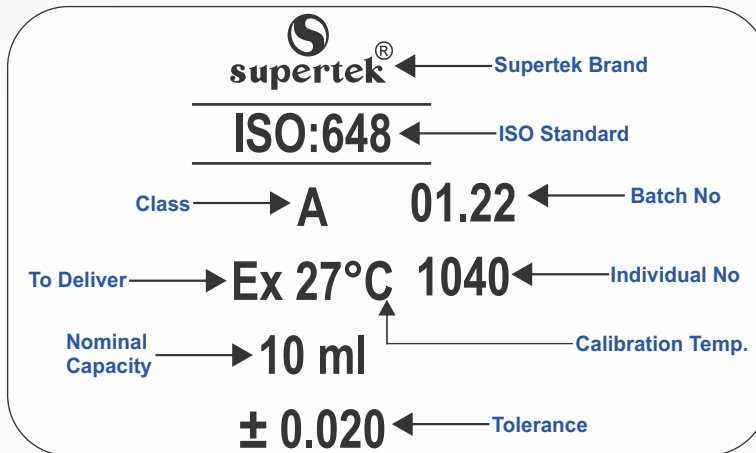

Special features of **supertek**[®] certified glassware

- Conforming international specification ISO and ASTM
- Individually calibrated and certified (A class only)
 - Multiple sizes & grades
 - Complete traceability

<i>Our printing criteria</i>	
<i>ISO Class A</i>	<i>Amber printing</i>
<i>ISO Class B</i>	<i>Amber printing</i>
<i>USP</i>	<i>Amber printing</i>
<i>Amber Glass</i>	<i>White printing</i>

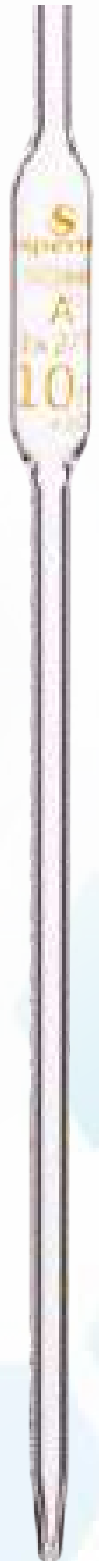

Pipettes

Playing a Key Role in Every Laboratory

- A volumetric pipette (also called as Bulb Pipette or Belly Pipette) allows only a specific (or fixed) amount of solution to be transferred
- Graduated pipettes allow for variable volumes of liquid to be transferred from one place to another.

Understanding the marking of Graduated Pipettes

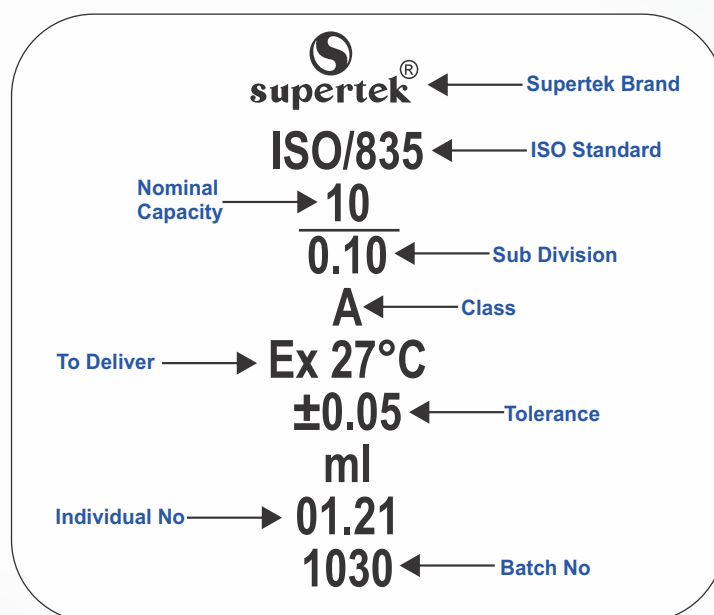

Comparison between Mohr and Serological Pipettes

MOHR	SEROLOGICAL
Delivery from zero mark to the last graduations mark	Delivery from zero mark to the tip
The graduations on these always end before the tip	The graduation marks continue to the tip
It can be used for partial delivery	It can be used for partial delivery

Right mix of quality and efficiency

Pipette, Transfer, Volumetric, With One Mark, Class A With Individual Works Certificate

- Calibrated at 27°C
- In compliance to Class A ISO-648/IS 1117:1975 standard
- Calibrated for delivery (TD, Ex)
- Generally used for accurate measurement and decanting of liquid
- Markings are made in permanent amber stain diffused into the surface of the glass for better visibility and durability
- A calibration certificate is provided with each Individual certified unit & same is available on our website

Cat No.	Capacity ml	Tolerance \pm ml	Pack Size
77.301.0001	1	0.008	10
77.301.0002	2	0.01	10
77.301.0003	3*	0.01	10
77.301.0004	4*	0.01	10
77.301.0005	5	0.015	10
77.301.0006	6*	0.015	10
77.301.0007	7*	0.015	10
77.301.0008	8*	0.02	10
77.301.0009	9*	0.02	10
77.301.0010	10	0.02	10
77.301.0015	15*	0.02	10
77.301.0020	20	0.03	10
77.301.0025	25	0.03	10
77.301.0050	50	0.05	10
77.301.0100	100	0.08	4

* Not covered under IS/ISO specifications

Pipette, Transfer, Volumetric, With One Mark, Class A With NABL Certificate

- Calibrated at 27°C
- In compliance to Class A ISO-648/IS 1117:1975 standard
- Calibrated for delivery (TD, Ex)
- Generally used for accurate measurement and decanting of liquid
- Markings are made in permanent amber stain diffused into the surface of the glass for better visibility and durability
- NABL Certificate is supplied with each unit



Cat No.	Capacity, ml	Tolerance \pm ml	Pack Size
72.301.0001	1	0.008	1
72.301.0002	2	0.01	1
72.301.0005	5	0.015	1
72.301.0010	10	0.02	1
72.301.0020	20	0.03	1
72.301.0025	25	0.03	1
72.301.0050	50	0.05	1
72.301.0100	100	0.08	1

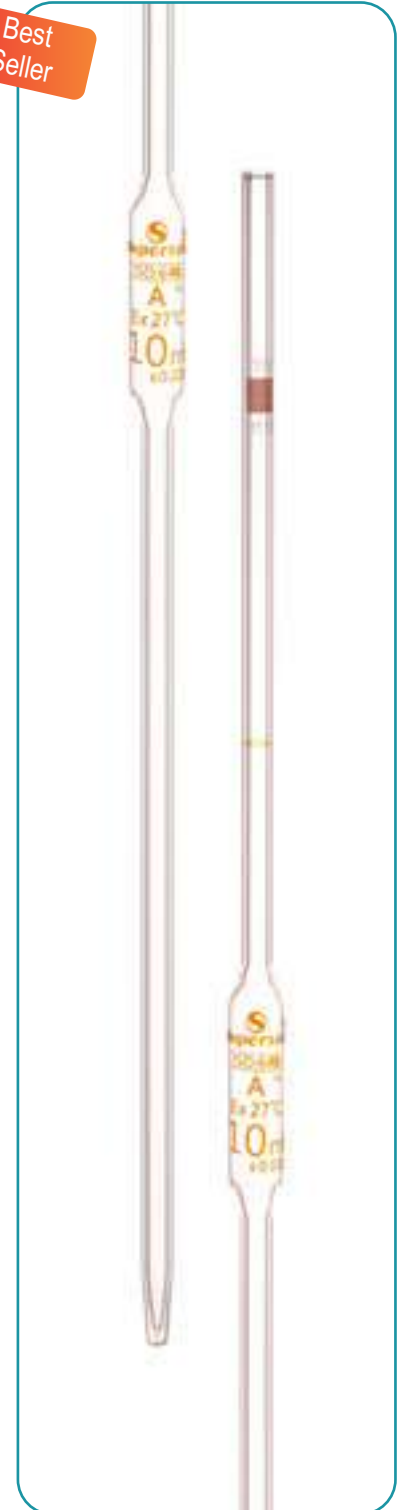

Pipette Filler See Page No. 162

USP Standard Pipette, Transfer, Volumetric, With One Mark, Class A With Individual USP Certificate

- Calibrated at 20°C
- In compliance to Class A ASTM E 969-02 standard
- Calibrated for delivery (TD, Ex)
- Generally used for accurate measurement and decanting of liquid
- Markings are made in permanent amber stain diffused into the surface of the glass for better visibility and durability
- A calibration certificate is provided with each Individual certified unit & same is available on our website



Cat No.	Capacity ml	Tolerance ± ml	Pack Size
50.311.0001	1	0.006	10
50.311.0501	1.5	0.006	10
50.311.0002	2	0.006	10
50.311.0502	2.5	0.01	10
50.311.0003	3	0.01	10
50.311.0004	4	0.01	10
50.311.0005	5	0.01	10
50.311.0006	6	0.01	10
50.311.0007	7	0.01	10
50.311.0008	8	0.02	10
50.311.0009	9	0.02	10
50.311.0010	10	0.02	10
50.311.0015	15	0.03	10
50.311.0020	20	0.03	10
50.311.0025	25	0.03	10
50.311.0030	30	0.03	10
50.311.0040	40	0.05	10
50.311.0050	50	0.05	10
50.311.0100	100	0.08	4



Pipette, Transfer, Volumetric, With One Mark, Class B

- Calibrated at 27°C
- In Compliance to Class B ISO-648/IS 1117:1975 standard
- Calibrated for delivery (TD, Ex)
- Markings are made in permanent amber stain diffused into the surface of the glass for better visibility and durability

Cat No.	Capacity ml	Tolerance ± ml	Pack Size
70.301.0001	1	0.015	10
70.301.0002	2	0.02	10
70.301.0005	5	0.03	10
70.301.0010	10	0.04	10
70.301.0020	20	0.06	10
70.301.0025	25	0.06	10
70.301.0050	50	0.1	10
70.301.0100	100	0.15	4

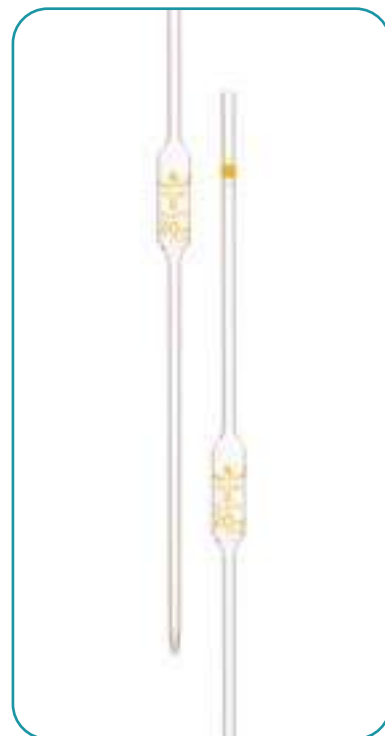

Pipettes-ASTM, Transfer, Volumetric, With One Mark, Class B

- In Compliance to Class B ASTM E-969-02
- Calibrated for delivery
- Generally used for accurate measurement and decanting of liquid

Cat No.	Capacity ml	Tolerance \pm ml	Pack Size
48.301.0001	1	0.012	10
48.301.0002	2	0.012	10
48.301.0003	3	0.02	10
48.301.0004	4	0.02	10
48.301.0005	5	0.02	10
48.301.0006	6	0.03	10
48.301.0007	7	0.03	10
48.301.0008	8	0.04	10
48.301.0009	9	0.04	10
48.301.0010	10	0.04	10
48.301.0015	15	0.06	10
48.301.0020	20	0.06	10
48.301.0025	25	0.06	10
48.301.0030	30*	0.06	10
48.301.0040	40*	0.10	10
48.301.0050	50	0.10	10
48.301.0100	100	0.16	4

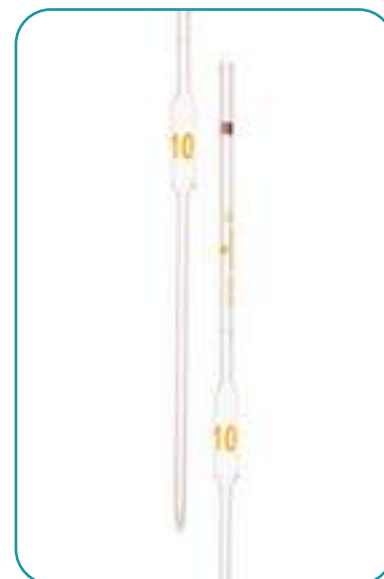

ASTM
969-02

Amber Color Pipette, Transfer, Volumetric, With One Mark, Class A With Individual Works Certificate

- Calibrated at 27°C
- In compliance to Class A ISO-648/IS 1117:1975 standard
- Calibrated for delivery (TD, Ex)
- Generally used for accurate measurement and decanting of liquid
- A calibration certificate is provided with each Individual certified unit & same is available on our website
- Amber color is applied to reduce UV light penetration

Cat No.	Capacity ml	Tolerance \pm ml	Pack Size
75.301.0001	1	0.008	10
75.301.0002	2	0.01	10
75.301.0003	3*	0.01	10
75.301.0004	4*	0.01	10
75.301.0005	5	0.015	10
75.301.0006	6*	0.015	10
75.301.0007	7*	0.015	10
75.301.0008	8*	0.02	10
75.301.0009	9*	0.02	10
75.301.0010	10	0.02	10
75.301.0015	15*	0.02	10
75.301.0020	20	0.03	10
75.301.0025	25	0.03	10
75.301.0050	50	0.05	10
75.301.0100	100	0.08	4



ISO 648
IS 1117

Amber Color Pipette, Transfer, Volumetric, With One Mark, Class A With NABL Certificate

- Calibrated at 27°C
- In compliance to Class A ISO-648/IS 1117:1975 standard
- Calibrated for delivery (TD, Ex)
- Generally used for accurate measurement and decanting of liquid
- Amber color is applied to reduce UV light penetration
- NABL Certificate is supplied with each unit



Cat No.	Capacity, ml	Tolerance ± ml	Pack Size
73.301.0001	1	0.008	1
73.301.0002	2	0.01	1
73.301.0003	3*	0.01	1
73.301.0004	4*	0.01	1
73.301.0005	5	0.015	1
73.301.0006	6*	0.015	1
73.301.0007	7*	0.015	1
73.301.0008	8*	0.02	1
73.301.0009	9*	0.02	1
73.301.0010	10	0.02	1
73.301.0015	15*	0.02	1
73.301.0020	20	0.03	1
73.301.0025	25	0.03	1
73.301.0050	50	0.05	1
73.301.0100	100	0.08	1

Amber Color USP Standard Pipette, Transfer, Volumetric, With One Mark, Class A With Individual Certificate

- Calibrated at 20°C
- In compliance to Class A ASTM E-969-02 standard
- Calibrated for delivery (TD, Ex)
- Generally used for accurate measurement and decanting of liquid
- A calibration certificate is provided with each Individual certified unit & same is available on our website



Cat No.	Capacity, ml	Tolerance ± ml	Pack Size
74.301.0001	1	0.006	10
74.301.0002	2	0.006	10
74.301.0005	5	0.01	10
74.301.0010	10	0.02	10
74.301.0020	20	0.03	10
74.301.0025	25	0.03	10
74.301.0050	50	0.05	10
74.301.0100	100	0.08	4



Pipette, Graduated, Mohr Type, Class A With Individual Works Certificate

- Calibrated at 27°C
- In compliance to Class A ISO 835 / IS 4162:1985 Standard
- These pipettes are graduated for delivery from zero mark at top to the last graduation mark.
- Sturdy, designed to last long usage
- Markings are made in permanent amber stain diffused into the surface of the glass for better visibility and durability
- A calibration certificate is provided with each Individual certified unit & same is available on our website

Cat No.	Capacity ml	Sub. Div ml	Tolerance \pm ml	Pack Size
77.302.0101	0.1	0.01	0.006	10
77.302.0102	0.2	0.01	0.006	10
77.302.0001	1	0.01	0.007	10
77.302.0011	1	0.1	0.007	10
77.302.0002	2	0.02	0.01	10
77.302.0022	2	0.1	0.01	10
77.302.0005	5	0.05	0.03	10
77.302.0055	5	0.1	0.03	10
77.302.0010	10	0.1	0.05	10
77.302.0025	25	0.2	0.1	10

Pipette, Graduated, Mohr Type, Class A With NABL Certificate

- Calibrated at 27°C
- In compliance to Class A ISO 835 / IS 4162:1985
- These pipettes are graduated for delivery from zero mark at top to the last graduation mark.
- Sturdy, designed to last long usage
- Markings are made in permanent amber stain diffused into the surface of the glass for better visibility and durability
- NABL Certificate is supplied with each unit



Cat No.	Capacity, ml	Sub. Div ml	Tolerance, \pm ml	Pack Size
72.302.0101	0.1	0.01	0.006	1
72.302.0102	0.2	0.01	0.006	1
72.302.0001	1	0.01	0.007	1
72.302.0011	1	0.1	0.007	1
72.302.0002	2	0.02	0.01	1
72.302.0022	2	0.1	0.01	1
72.302.0005	5	0.05	0.03	1
72.302.0055	5	0.1	0.03	1
72.302.0010	10	0.1	0.05	1
72.302.0025	25	0.2	0.1	1

Pipette, Graduated, Mohr Type, Class B

- Calibrated at 27°C
- In compliance to Class B ISO 835 / IS 4162:1985 Standard
- Sturdy, designed to last long usage
- These pipettes are graduated for delivery from zero mark at top to the last graduation mark.
- Markings are made in permanent amber stain diffused into the surface of the glass for better visibility and durability

Cat No.	Capacity ml	Sub Div. ml	Tolerance \pm ml	Pack Size
70.302.0101	0.1	0.01	0.01	10
70.302.0102	0.2	0.01	0.01	10
70.302.0001	1	0.01	0.01	10
70.302.0011	1	0.1	0.01	10
70.302.0002	2	0.02	0.02	10
70.302.0022	2	0.1	0.02	10
70.302.0005	5	0.05	0.05	10
70.302.0055	5	0.1	0.05	10
70.302.0010	10	0.1	0.1	10
70.302.0025	25	0.2	0.2	10

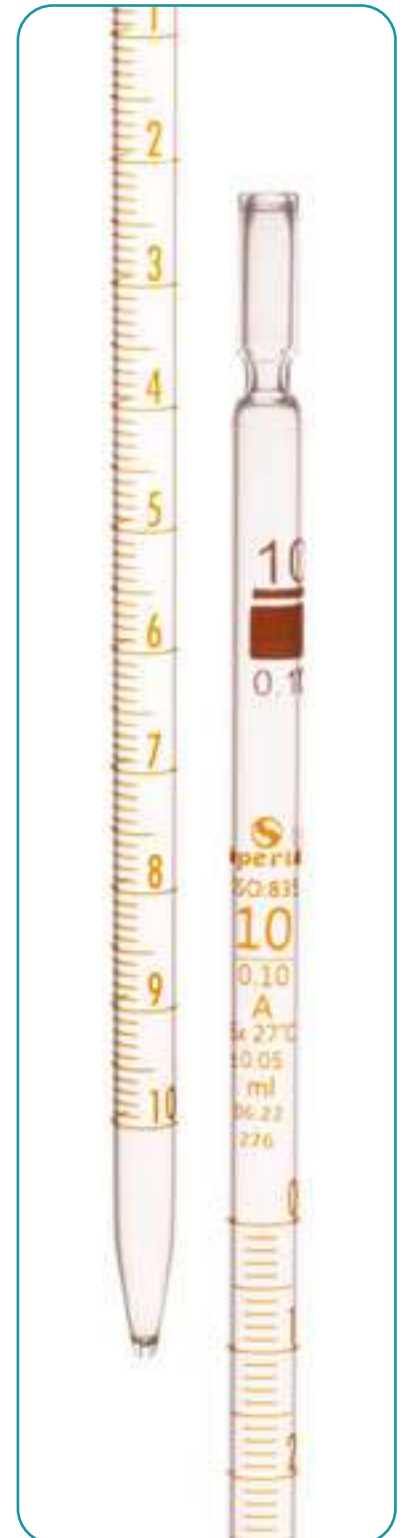

ISO 835
IS 4162

Amber Color Pipette, Graduated, Mohr Type, Class A With Individual Works

Certificate

- Calibrated at 27°C
- In compliance to Class A ISO 835 / IS 4162:1985 Standard
- These pipettes are graduated for delivery from zero mark at top to the last graduation mark.
- Sturdy, designed to last long usage
- Amber color is applied to reduce UV light penetration
- A calibration certificate is provided with each Individual certified unit & same is available on our website

Till Stock Lasts

Cat No.	Capacity ml	Sub Div. ml	Tolerance \pm ml	Pack Size
75.302.0011	1	0.1	0.007	10
75.302.0022	2	0.1	0.01	10
75.302.0055	5	0.1	0.03	10

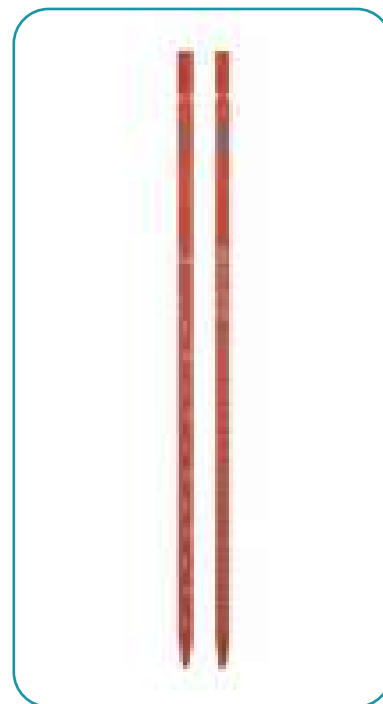

USP Graduated Pipettes, Serological, Class A With Individual USP Certificate

- Calibrated at 20°C
- In compliance to ASTM 1293-02 standard
- Calibrated for delivery (TD, Ex)
- Generally used for accurate measurement and decanting of liquid
- Markings are made in permanent amber stain diffused into the surface of the glass for better visibility and durability
- A calibration certificate is provided with each Individual certified unit & same is available on our website



Cat No.	Capacity, ml	Sub.-div. ml	Tolerance, (+ml)	Pack Size
50.303.0005	0.1	0.01	0.010	10
50.303.0010	0.2	0.01	0.010	10
50.303.0015	1	0.01	0.010	10
50.303.0020	2	0.02	0.010	10
50.303.0025	5	0.05	0.020	10
50.303.0030	10	0.1	0.030	10
50.303.0035	25	0.2	0.050	10



Pipette, Graduated, Serological, Class A With Individual Works Certificate

- Calibrated at 27°C
- In compliance to Class A ISO 835 / IS 4162:1985 Standard
- These pipettes are calibrated to deliver from any graduation line to tip
- Sturdy, designed to last long usage
- Markings are made in permanent amber stain diffused into the surface of the glass for better visibility and durability
- A calibration certificate is provided with each Individual certified unit & same is available on our website

Cat No.	Capacity ml	Sub-div. ml	Tolerance \pm ml	Pack Size
77.303.0101	0.1	0.01	0.006	10
77.303.0102	0.2	0.01	0.006	10
77.303.0001	1	0.01	0.007	10
77.303.0011	1	0.1	0.007	10
77.303.0002	2	0.02	0.01	10
77.303.0022	2	0.1	0.01	10
77.303.0005	5	0.05	0.03	10
77.303.0055	5	0.1	0.03	10
77.303.0010	10	0.1	0.05	10
77.303.0025	25	0.2	0.1	10

Pipette, Graduated, Serological, Class A With NABL Certificate

- Calibrated at 27°C
- In compliance to Class A ISO 835 / IS 4162:1985 Standard
- These pipettes are calibrated to deliver from any graduation line to tip
- Sturdy, designed to last long usage
- Markings are made in permanent amber stain diffused into the surface of the glass for better visibility and durability
- NABL Certificate is supplied with each unit



Cat No.	Capacity ml	Sub-div. ml	Tolerance \pm ml	Pack Size
72.303.0101	0.1	0.01	0.006	1
72.303.0102	0.2	0.01	0.006	1
72.303.0001	1	0.01	0.007	1
72.303.0011	1	0.1	0.007	1
72.303.0002	2	0.02	0.01	1
72.303.0022	2	0.1	0.01	1
72.303.0005	5	0.05	0.03	1
72.303.0055	5	0.1	0.03	1
72.303.0010	10	0.1	0.05	1
72.303.0025	25	0.2	0.1	1

Pipette, Graduated, Serological, Class B

- Calibrated at 27°C
- In compliance to Class B ISO 835 / IS 4162:1985 Standard
- Sturdy, designed to last long usage
- These pipettes are calibrated to deliver from any graduation line to tip
- Markings are made in permanent amber stain diffused into the surface of the glass for better visibility and durability

Cat. No.	Capacity ml	Sub-div. ml	Tolerance \pm ml	Pack Size
70.303.0101	0.1	0.01	0.01	10
70.303.0102	0.2	0.01	0.01	10
70.303.0001	1	0.01	0.01	10
70.303.0011	1	0.1	0.01	10
70.303.0002	2	0.02	0.02	10
70.303.0022	2	0.1	0.02	10
70.303.0005	5	0.05	0.05	10
70.303.0055	5	0.1	0.05	10
70.303.0010	10	0.1	0.1	10
70.303.0025	25	0.2	0.2	10

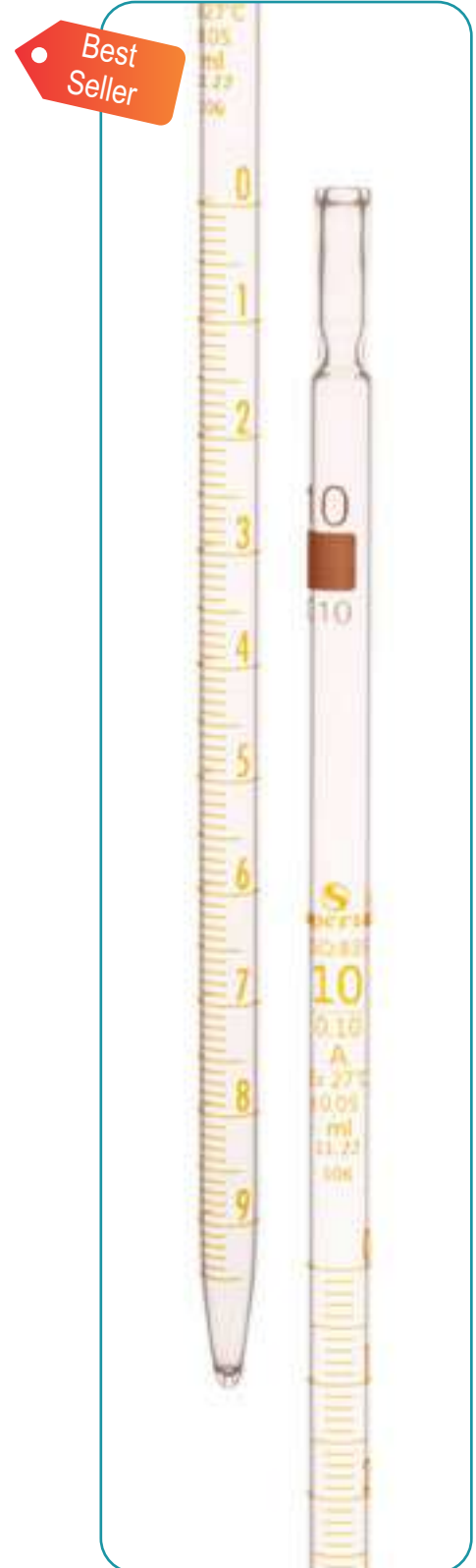

Pipette, Pasteur

- Boro Glass 7.0 Expansion

Cat No.	Length, mm	Pack Size
70.310.0145	145	1000
70.310.0230	230	1000

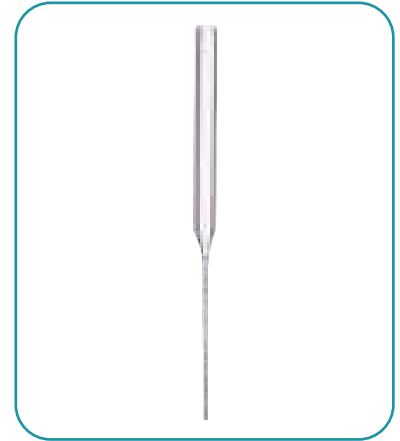

Pipette, Dropping With Capillary Jet

- Pipette with rubber teat

Cat No.	Length, mm	Pack Size
70.312.0005	5 cm. with 5 cm. jet	10
70.312.0008	8 cm. with 10 cm. jet	10



Pipette, Dropper

- Pipette with rubber teat

Cat No.	Length, mm	Pack Size
70.314.0150	150	10



Milk Pipette Bacteriological

- Complies with IS 2025
- These Pipettes are used for the bacteriological examination of milk
- 1.1 ml is graduated at 0.5 to 1.1 ml
- 2.2 ml is graduated at 1.0, 2.0, 2.1 and 2.2 ml

Cat No.	Capacity ml	Tolerance \pm ml	Pack Size
70.316.0111	1.1	0.03	10
70.316.0222	2.2	0.04	10



Milk Pipette Gerber

- Complies with IS 1223 (Part II)
- These Pipettes are used for testing milk by the Gerber method.
- Sturdy, designed to last long
- Gerber Milk Pipettes are one-mark transfer Pipettes for measuring 10.75 ml
- They can be also be used in rural Milk Collection Centres

Cat No.	Capacity ml	Tolerance \pm ml	Pack Size
70.318.1075	10.75	0.03	10

Milk Pipette Gerber, Class A With Individual Works Certificate

Cat No.	Capacity ml	Tolerance \pm ml	Pack Size
77.318.1075	10.75	0.015	10

Milk Pipette Gerber, Class A With NABL Certificat

Cat No.	Capacity ml	Tolerance \pm ml	Pack Size
72.318.1075	10.75	0.015	1



Drum Sampling Tube Length 1000 Mm, Dia 19mm Heavy Wall

Cat No.	Length, mm	Pack Size
70.322.1000	1000	1



Pipettes Automatic Quick Acting For Rapid Work of Approximate Accuracy (Tilt Measure) Complete With Conical Flask, Interchangeable Joint Fitting

Cat No.	Capacity ml.	Reservoir Cap. Minimum	Pack Size
70.306.0001	1	100	2
70.306.0002	2	100	2
70.306.0005	5	250	2
70.306.0010	10	250	2
70.306.0020	20	500	2
70.306.0025	25	500	2



Volumetric Flasks

An Integral Part of Every Laboratory

supertek[®] Volumetric flasks are made from Low expansion 3.3 Borosilicate Glass. All flasks are calibrated to contain (TC/In) at 27°C/20°C reference temperature, which is indicated on the label. These flasks are calibrated on state of the art fully automatic calibration machine. Flask have uniform thickness and available in clear and amber glass. Total volume is marked with a circular graduation mark. Volumetric flask are made for precise dilutions and preparations of standard solutions.

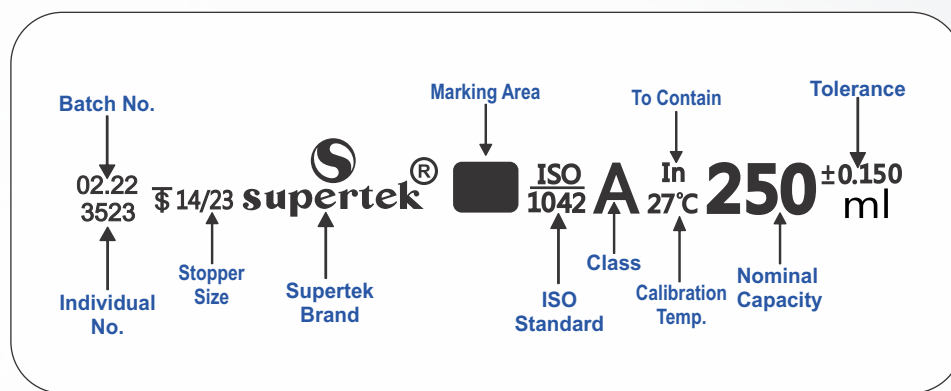

<i>Our printing criteria</i>	
<i>Amber glass all volumetric flask</i>	<i>White Printing</i>
<i>Clear glass Volumetric flask Class-B</i>	<i>Amber Printing</i>
<i>Class - A ISO, USP Volumetric flask</i>	<i>Amber Printing</i>
<i>Class - A ASTM Volumetric flask</i>	<i>Amber Printing</i>

Special features of **supertek[®]** certified glassware

- Conforming international specification ISO and ASTM
- Individually calibrated and certified (A class only)
 - Multiple sizes & grades
 - Complete traceability



Right mix of quality and efficiency

Flask Volumetric, With Interchangeable Glass and Super Stopper™, Class A With Individual Works Certificate

- Calibrated at 27°C
- In Compliance to Class A ISO 1042 / IS 915
- Manufactured from 3.3 borosilicate glass for corrosion-free performance
- A calibration certificate is provided with each Individual certified product & same is available on our website

Cat. No.	Capacity ml	Tolerance, ± ml	Stopper Size	Pack Size
77.418.0001	1*	0.025	7/16	6
77.418.0002	2*	0.025	7/16	6
77.418.0005	5*	0.025	10/19 [#]	2
77.418.0010	10*	0.025	10/19 [#]	2
77.418.0015	15*	0.025	10/19	2
77.418.0020	20*	0.04	10/19	2
77.418.0025	25	0.04	10/19	2
77.418.0030	30	0.04	10/19	2
77.418.0050	50	0.06	12/21	2
77.418.0075	75	0.06	12/21	2
77.418.0100	100	0.1	14/23	2
77.418.0150	150	0.1	14/23	2
77.418.0200	200	0.15	14/23	2
77.418.0250	250	0.15	14/23	2
77.418.0300	300	0.15	14/23	2
77.418.0500	500	0.25	19/26	2
77.418.1000	1000	0.4	24/29	2
77.418.2000	2000	0.6	29/32	1
77.418.5000	5000	1.2	34/35	1

Supertek standard

* upto 20ml sizes are of trapezoidal shape



Flask Volumetric, With Interchangeable Glass and Super Stopper™, Class A With NABL Certificate

- Calibrated at 27°C
- In Compliance to Class A ISO 1042 / IS 915
- Manufactured from 3.3 borosilicate glass for corrosion-free performance
- NABL Certificate is supplied with each unit



Cat. No.	Capacity ml	Tolerance ± ml	Stopper Size	Pack Size
72.418.0005	5*	0.025	10/19 [#]	1
72.418.0010	10*	0.025	10/19 [#]	1
72.418.0015	15*	0.025	10/19	1
72.418.0020	20*	0.04	10/19	1
72.418.0025	25	0.04	10/19	1
72.418.0030	30	0.04	10/19	1
72.418.0050	50	0.06	12/21	1
72.418.0075	75	0.06	12/21	1
72.418.0100	100	0.1	14/23	1
72.418.0150	150	0.1	14/23	1
72.418.0200	200	0.15	14/23	1
72.418.0250	250	0.15	14/23	1
72.418.0300	300	0.15	14/23	1
72.418.0500	500	0.25	19/26	1
72.418.1000	1000	0.4	24/29	1
72.418.2000	2000	0.6	29/32	1

Supertek standard

* upto 20ml sizes are of trapezoidal shape



Flask Volumetric, With Interchangeable Glass and Super Stopper™, Class B

- Calibrated at 27°C
- In Compliance to Class B ISO 1042 / IS 915
- Manufactured from 3.3 borosilicate glass for corrosion-free performance

Cat. No.	Capacity ml	Tolerance, ± ml	Stopper Size	Pack Size
70.418.0001	1*	0.05	7/16	6
70.418.0002	2*	0.05	7/16	6
70.418.0005	5*	0.05	10/19 [#]	2
70.418.0010	10*	0.05	10/19 [#]	2
70.418.0020	20*	0.08	10/19	2
70.418.0025	25	0.08	10/19	2
70.418.0050	50	0.12	12/21	2
70.418.0100	100	0.2	14/23	2
70.418.0200	200	0.3	14/23	2
70.418.0250	250	0.3	14/23	2
70.418.0500	500	0.5	19/26	2
70.418.1000	1000	0.8	24/29	2
70.418.2000	2000	1.2	29/32	1

Supertek standard

* upto 20ml sizes are of trapezoidal shape

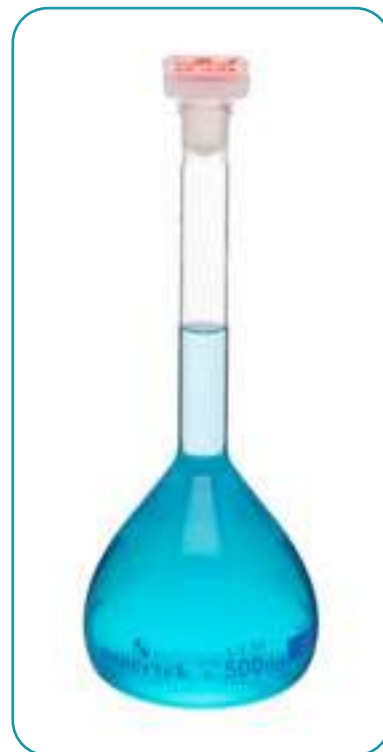

Flask Volumetric Amber, With Interchangeable Glass and Super Stopper™, Class B

- Calibrated at 27°C
- In Compliance to Class B ISO 1042 / IS 915
- Manufactured from 3.3 borosilicate glass for corrosion-free performance
- Amber color helps in reducing UV light penetration

Cat. No.	Capacity ml	Tolerance ± ml	Stopper Size	Pack Size
71.418.0001	1*	0.05	7/16	6
71.418.0002	2*	0.05	7/16	6
71.418.0005	5*	0.05	10/19 [#]	2
71.418.0010	10*	0.05	10/19 [#]	2
71.418.0020	20*	0.08	10/19	2
71.418.0025	25	0.08	10/19	2
71.418.0050	50	0.12	12/21	2
71.418.0100	100	0.2	14/23	2
71.418.0200	200	0.3	14/23	2
71.418.0250	250	0.3	14/23	2
71.418.0500	500	0.5	19/26	2
71.418.1000	1000	0.8	24/29	2
71.418.2000	2000	1.2	29/32	1

Supertek standard

* upto 20ml sizes are of trapezoidal shape



Flask Volumetric Amber, With Interchangeable Glass and Super Stopper™, Class A With Individual Works Certificate

- Calibrated at 27°C
- In Compliance to Class A ISO 1042 / IS 915
- Manufactured from 3.3 borosilicate glass for corrosion-free performance
- Amber color helps in reducing UV light penetration
- A calibration certificate is provided with each Individual certified unit & same is available on our website

Cat. No.	Capacity ml	Tolerance ± ml	Stopper Size	Pack Size
75.418.0001	1*	0.025	7/16	6
75.418.0002	2*	0.025	7/16	6
75.418.0005	5	0.025	10/19 [†]	2
75.418.0010	10	0.025	10/19 [†]	2
75.418.0015	15	0.025	10/19	2
75.418.0020	20	0.04	10/19	2
75.418.0025	25	0.04	10/19	2
75.418.0030	30	0.04	10/19	2
75.418.0050	50	0.06	12/21	2
75.418.0075	75	0.06	12/21	2
75.418.0100	100	0.1	14/23	2
75.418.0150	150	0.1	14/23	2
75.418.0200	200	0.15	14/23	2
75.418.0250	250	0.15	14/23	2
75.418.0300	300	0.15	14/23	2
75.418.0500	500	0.25	19/26	2
75.418.1000	1000	0.4	24/29	2
75.418.2000	2000	0.6	29/32	1
75.418.5000	5000**	1.2	34/35	1

Supertek standard

* upto 20ml sizes are of trapezoidal shape

** with Interchangeable glass and PP stopper

Flask Volumetric Amber, With Interchangeable Glass and Super Stopper™, Class A With NABL Certificate

- Calibrated at 27°C
- In Compliance to Class A ISO 1042 / IS 915
- Manufactured from 3.3 borosilicate glass for corrosion-free performance
- Amber color helps in reducing UV light penetration
- NABL Certificate is supplied with each unit



Cat. No.	Capacity ml	Tolerance ± ml	Stopper Size	Pack Size
73.418.0005	5	0.025	10/19 [†]	1
73.418.0010	10	0.025	10/19 [†]	1
73.418.0020	20	0.04	10/19	1
73.418.0025	25	0.04	10/19	1
73.418.0050	50	0.06	12/21	1
73.418.0100	100	0.1	14/23	1
73.418.0200	200	0.15	14/23	1
73.418.0250	250	0.15	14/23	1
73.418.0500	500	0.25	19/26	1
73.418.1000	1000	0.4	24/29	1
73.418.2000	2000	0.6	29/32	1

Supertek standard

* upto 20ml sizes are of trapezoidal shape



Flask Volumetric, With Interchangeable Glass and Super Stopper™, Class A With USP (US PHARMACOPEIA) Certificate

- Calibrated at 20°C
- Accuracy as per ASTM E 288-03 Standard
- Manufactured from 3.3 borosilicate glass for corrosion-free performance
- A calibration certificate is provided with each Individual certified unit & same is available on our website



Cat. No.	Capacity, ml	Tolerance, ± ml	Stopper Size	Pack Size
50.419.0005	5*	0.02	10/19	2
50.419.0010	10*	0.02	10/19	2
50.419.0025	25	0.03	10/19	2
50.419.0050	50	0.05	12/21	2
50.419.0100	100	0.08	14/23	2
50.419.0200	200	0.1	14/23	2
50.419.0250	250	0.12	14/23	2
50.419.0500	500	0.15	19/26	2
50.419.1000	1000	0.3	24/29	2
50.419.2000	2000	0.5	29/32	1
50.419.5000	5000	1.25	34/35	1

* upto 20ml sizes are of trapezoidal shape



Flask Volumetric Amber, With Interchangeable Glass and Super Stopper™, Class A With USP (US PHARMACOPEIA) Certificate

- Calibrated at 20°C
- Accuracy as per ASTM E 288-03 Standard
- Manufactured from 3.3 borosilicate glass for corrosion-free performance
- Amber color helps in reducing UV light penetration
- A calibration certificate is provided with each Individual certified unit & same is available on our website



Cat. No.	Capacity, ml	Tolerance, ± ml	Stopper Size	Pack Size
74.419.0005	5*	0.02	10/19	2
74.419.0010	10*	0.02	10/19	2
74.419.0025	25	0.03	10/19	2
74.419.0050	50	0.05	12/21	2
74.419.0100	100	0.08	14/23	2
74.419.0200	200	0.1	14/23	2
74.419.0250	250	0.12	14/23	2
74.419.0500	500	0.15	19/26	2
74.419.1000	1000	0.3	24/29	2
74.419.2000	2000	0.5	29/32	1

* upto 20ml sizes are of trapezoidal shape

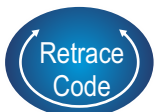

Flask Volumetric, Color Coded, With Interchangeable Glass and Super Stopper™, Class A With Individual Works Certificate

- Calibrated at 27°C
- In Compliance to Class A ISO 1042 / IS 915
- Manufactured from 3.3 borosilicate glass for corrosion-free performance
- Color Coded for easy identification
- A calibration certificate is provided with each Individual certified unit & same is available on our website

Cat. No.	Capacity ml	Tolerance, ± ml	Stopper Size	Pack Size
77.417.0005	5*	0.025	10/19 [#]	2
77.417.0010	10*	0.025	10/19 [#]	2
77.417.0020	20*	0.04	10/19	2
77.417.0025	25	0.04	10/19	2
77.417.0050	50	0.06	12/21	2
77.417.0100	100	0.1	14/23	2
77.417.0200	200	0.15	14/23	2
77.417.0250	250	0.15	14/23	2
77.417.0500	500	0.25	19/26	2
77.417.1000	1000	0.4	24/29	2
77.417.2000	2000	0.6	29/32	1

Supertek standard

* upto 20ml sizes are of trapezoidal shape

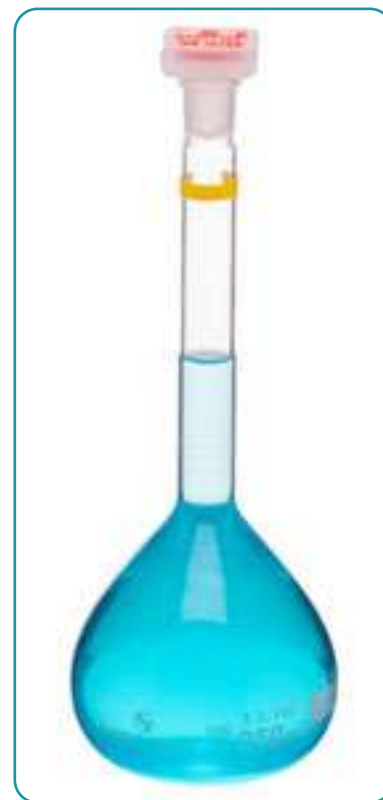

Flask Volumetric Amber, With Special White Mark, Interchangeable Glass and Super Stopper™, Class A With Individual Works Certificate

- Calibrated at 27°C
- In Compliance to Class A ISO 1042 / IS 915
- Manufactured from 3.3 borosilicate glass for corrosion-free performance
- Amber color helps in reducing UV light penetration
- Triangular white mark provided for easy identification
- * A calibration certificate is provided with each Individual certified unit & same is available on our website

Cat. No.	Capacity ml	Tolerance ± ml	Stopper Size	Pack Size
75.417.0050	50	0.06	12/21	2
75.417.0100	100	0.1	14/23	2
75.417.0200	200	0.15	14/23	2
75.417.0250	250	0.15	14/23	2

Supertek standard



Dish Washer
Durable
Print

ISO 1042
IS 915

Retrace
Code

**Flask Volumetric, Wide Mouth With Interchangeable Glass and Super Stopper™
Class 'A' With Individual Certificate**

- Calibrated at 27°C
- In Compliance to Class A ISO 1042 / IS 915
- Manufactured from 3.3 borosilicate glass for corrosion-free performance
- Designed with wide mouth for testing bigger tablet without making it in powder form
- A calibration certificate is provided with each Individual certified unit & same is available on our website

Cat. No.	Capacity, ml	Tolerance, ± ml	Stopper Size	Pack Size
77.439.0020	20*	0.06	12/21	2
77.439.0025	25	0.06	12/21	2
77.439.0050	50	0.1	14/23	2
77.439.0100	100#	0.15	19/26	2
77.439.0200	200*	0.2	19/26	2
77.439.0250	250*	0.2	19/26	2
77.439.0500	500	0.4	24/29	2
77.439.1000	1000	0.6	29/32	2

Not in ISO / IS standards

* upto 20ml sizes are of trapezoidal shape



**Amber Colour Flask Volumetric, Wide Mouth With Interchangeable Glass
and Super Stopper™ Class 'A' With Individual certificate**

- Calibrated at 27°C
- In Compliance to Class A ISO 1042 / IS 915
- Manufactured from 3.3 borosilicate glass for corrosion-free performance
- Designed with wide mouth for testing bigger tablet without making it in powder form
- Amber color helps in reducing UV light penetration
- A calibration certificate is provided with each Individual certified unit & same is available on our website

Cat. No.	Capacity, ml	Tolerance, ± ml	Stopper Size	Pack Size
75.439.0020	20*	0.06	12/21	2
75.439.0025	25	0.06	12/21	2
75.439.0050	50	0.1	14/23	2
75.439.0100	100#	0.15	19/26	2
75.439.0200	200*	0.2	19/26	2
75.439.0250	250*	0.2	19/26	2
75.439.0500	500	0.4	24/29	2
75.439.1000	1000	0.6	29/32	2

Not in ISO / IS standards

* upto 20ml sizes are of trapezoidal shape

**Flask Volumetric, Wide Mouth With Interchangeable Glass and Super Stopper™
Class 'A' With USP Certificate**

- Calibrated at 20°C
- Accuracy as per ASTM E 288-03 Standard
- Manufactured from 3.3 borosilicate glass for corrosion-free performance
- A calibration certificate is provided with each Individual certified unit & same is available on our website



Cat. No.	Capacity, ml	Tolerance, ± ml	Stopper Size	Pack Size
50.439.0020	20*	0.03	12/21	2
50.439.0025	25	0.03	12/21	2
50.439.0050	50	0.05	14/23	2
50.439.0100	100	0.08	19/26	2
50.439.0200	200	0.1	19/26	2
50.439.0250	250	0.12	19/26	2
50.439.1000	1000	0.3	29/32	2

* upto 20ml sizes are of trapezoidal shape



Amber Flask Volumetric, Wide Mouth With Interchangeable Glass and Super Stopper™ Class 'A' With USP Certificate

- Calibrated at 20°C
- Accuracy as per ASTM E 288-03 Standard
- Manufactured from 3.3 borosilicate glass for corrosion-free performance
- A calibration certificate is provided with each Individual certified unit & same is available on our website



Cat. No.	Capacity, ml	Tolerance, ± ml	Stopper Size	Pack Size
74.439.0020	20*	0.03	12/21	2
74.439.0025	25	0.03	12/21	2
74.439.0050	50	0.05	14/23	2
74.439.0100	100	0.08	19/26	2
74.439.0200	200	0.1	19/26	2
74.439.0250	250	0.12	19/26	2
74.439.1000	1000	0.3	29/32	2

* upto 20ml sizes are of trapezoidal shape



Volumetric Flask-ASTM, Wide Mouth Heavy Duty, With Glass Stopper, Class A with Individual Works Certificate

- Calibrated at 20°C
- Complies with ASTM E 288 specifications
- Calibrated to contain (TC, IN)
- Manufactured from 3.3 borosilicate glass for corrosion-free performance
- A calibration certificate is provided with each Individual certified unit & same is available on our website



Cat. No.	Capacity, ml	Tolerance, ± ml	Stopper Size	Pack Size
46.424.0005	5	0.02	13	1
46.424.0010	10	0.02	13	1
46.424.0020	20	0.04	13	1
46.424.0025	25	0.03	13	1
46.424.0030	30	0.03	13	1
46.424.0050A	50	0.05	13	1
46.424.0050B	50	0.05	19	1
46.424.0100	100	0.08	16	1
46.424.0150	150	0.08	16	1
46.424.0200	200	0.1	19	1
46.424.0250	250	0.12	19	1
46.424.0300	300	0.12	19	1
46.424.0400	400	0.2	19	1
46.424.0500	500	0.2	19	1
46.424.0750	750	0.2	22	1
46.424.0900	900	0.3	22	1
46.424.1000	1000	0.3	22	1
46.424.1500	1500	0.3	27	1
46.424.2000	2000	0.5	27	1
46.424.4000	4000	1	38	1



Volumetric Flask-ASTM Amber, Wide Mouth Heavy Duty, With Glass Stopper, Class A with Individual Works Certificate

- Calibrated at 20°C
- Complies with ASTM E 288 specifications
- Calibrated to contain (TC, IN)
- Manufactured from 3.3 borosilicate glass for corrosion-free performance
- Printed in white color
- A calibration certificate is provided with each Individual certified unit & same is available on our website



Cat. No.	Capacity, ml	Tolerance, ± ml	Stopper Size	Pack Size
46.434.0005	5	0.02	13	1
46.434.0010	10	0.02	13	1
46.434.0020	20	0.04	13	1
46.434.0025	25	0.03	13	1
46.434.0050	50	0.05	13	1
46.434.0100	100	0.08	16	1
46.434.0200	200	0.1	19	1
46.434.0250	250	0.12	19	1
46.434.0400	400	0.2	19	1
46.434.0500	500	0.2	19	1
46.434.0700	750	0.2	22	1
46.434.0900	900	0.3	22	1
46.434.1000	1000	0.3	22	1
46.434.2000	2000	0.5	27	1



Volumetric Flask-ASTM, Narrow Mouth With Glass Stopper Class A with Individual Works Certificate

- Calibrated at 20°C
- Complies with ASTM E 288 specifications
- Manufactured from 3.3 borosilicate glass for corrosion-free performance
- A calibration certificate is provided with each Individual certified unit & same is available on our website



Cat. No.	Capacity, ml	Tolerance, ± ml	Stopper Size	Pack Size
46.403.0015	5	0.02	9	6
46.403.0025	10	0.02	9	6
46.403.0035	20	0.03	9	2
46.403.0045	25	0.03	9	2
46.403.0055	50	0.05	9	2
46.403.0065	100	0.08	13	2
46.403.0075	200	0.10	16	2
46.403.0085	250	0.12	16	2
46.403.0095	500	0.20	19	2
46.403.0100	1000	0.30	22	2
46.403.0105	2000	0.50	27	1

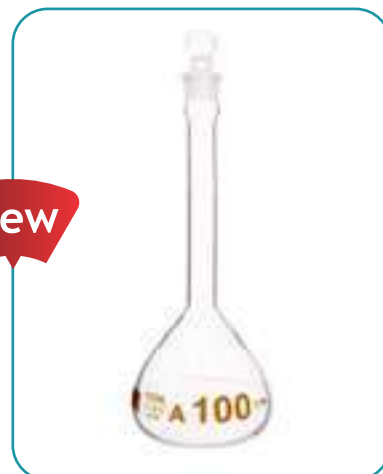

Amber Volumetric Flask-ASTM, Narrow Mouth With Glass Stopper Class A with Individual Works Certificate

- Calibrated at 20°C
- Complies with ASTM E 288 specifications
- Manufactured from 3.3 borosilicate glass for corrosion-free performance
- A calibration certificate is provided with each Individual certified unit & same is available on our website



Cat. No.	Capacity, ml	Tolerance, ± ml	Stopper Size	Pack Size
46.412.0015	5	0.02	9	6
46.412.0025	10	0.02	9	6
46.412.0035	20	0.03	9	2
46.412.0045	25	0.03	9	2
46.412.0055	50	0.05	9	2
46.412.0065	100	0.08	13	2
46.412.0075	200	0.10	16	2
46.412.0085	250	0.12	16	2
46.412.0095	500	0.20	19	2
46.412.0100	1000	0.30	22	2
46.412.0105	2000	0.50	27	1

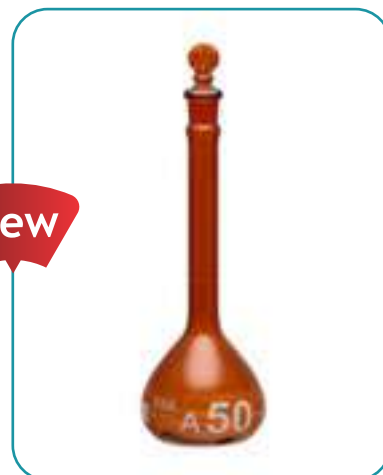



Flask Volumetric, With Interchangeable Glass and PP Stopper, Short Neck Class A with Individual Works Certificate

- Calibrated at 27°C
- In Compliance to Class A ISO 1042 / IS 915
- Manufactured from 3.3 borosilicate glass for corrosion-free performance
- A calibration certificate is provided with each Individual certified product & same is available on our website

Cat. No.	Capacity ml	Tolerance, \pm ml	Stopper Size	Pack Size
77.415.0010	10**	0.025	10/15	2
77.415.0020	20**	0.04	10/15	2
77.415.0025	25	0.04	10/15	2
77.415.0050	50	0.06	10/15	2
77.415.0100	100	0.1	14/15	2
77.415.0250	250	0.15	14/15	2
77.415.1000	1000	0.4	19/20	2

** 10 ml & 20 ml is supplied with trapezoidal shape for better stability

Short Neck



Short Neck Flasks Available Till Stock Lasts



Flask Volumetric, With Interchangeable Glass and PP Stopper, Short Neck, Class B

- Calibrated at 27°C
- In Compliance to Class B ISO 1042 / IS 915
- Manufactured from 3.3 borosilicate glass for corrosion-free performance

Cat. No.	Capacity ml	Tolerance, \pm ml	Stopper Size	Pack Size
70.415.0005	5**	0.05	10/15	2
70.415.0010	10**	0.05	10/15	2
70.415.0500	500	0.5	19/20	2
70.415.1000	1000	0.8	19/20	2

** 5 ml & 10 ml is supplied with trapezoidal shape for better stability

Flasks Volumetric Sugar Estimation With Two Marks Without Stopper, Class 'A' of B.S. 675:1953

- Calibrated at 27°C
- In Compliance to Class A BS 675
- Manufactured from 3.3 borosilicate glass for corrosion-free performance
- A calibration certificate is provided with each Individual certified unit

Cat. No.	Capacity, ml	Pack Size
77.440.0100	100 ml. and 110 ml.	2

Flasks Volumetric Sugar Estimation With Two Marks Without Stopper, Class 'B' of B.S. 675:1953

- Calibrated at 27°C
- Manufactured from 3.3 borosilicate glass for corrosion-free performance

Cat. No.	Capacity, ml	Pack Size
70.440.0100	100 ml. and 110 ml.	2

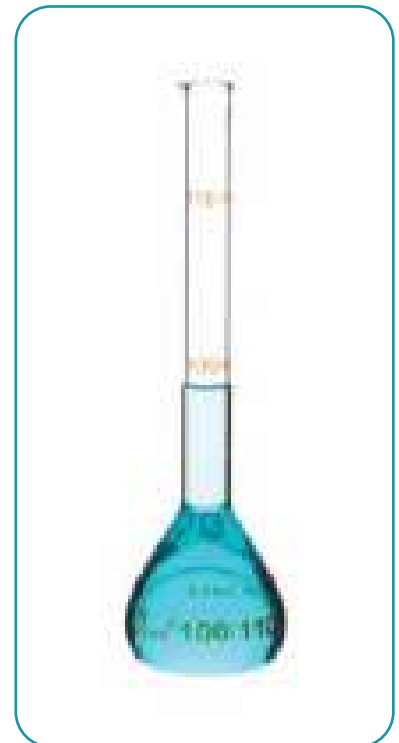

Measuring Cylinders

Easy to Use - Highly Accurate

supertek® Offers Measuring Cylinders with high accuracy. It helps with measuring the volume of a liquid and is also called as Mixing Cylinder. Measuring Cylinders are also used to determine displacement, which is a measurement of the change in the volume of water when additional materials are added to it. This means that the volume of solid objects and solutions can be determined using a measuring cylinder. The large hexagonal base in the cylinder prevents it rolling off a laboratory bench.

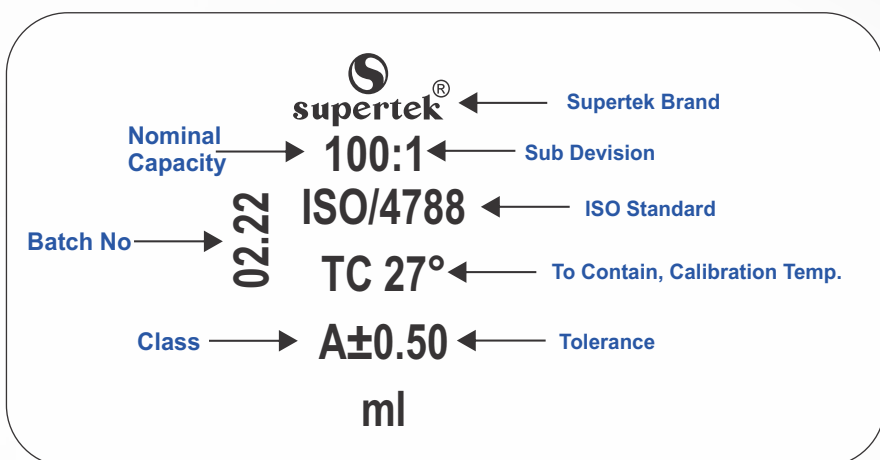

<i>Our printing criteria</i>	
ISO Class A	Amber printing
ISO Class B	Amber printing
USP	Amber printing
Amber Glass	White printing



Special features of supertek® certified glassware

- Conforming international specification ISO and ASTM
- Individually calibrated and certified (A class only)
 - Multiple sizes & grades
 - Complete traceability



Right mix of quality and efficiency

Measuring Cylinder, With Pour-out, Hexagonal Base, Class A With Individual Works Certificate

- Calibrated at 27°C
- In compliance to Class A DIN ISO 4788/IS 878 Standard
- Graduations in amber enamel
- Sturdy hexagonal base prevents roll-over and ensures greater stability
- A calibration certificate is provided with each Individual certified unit & same is available on our website

Cat. No.	Capacity ml	Sub-div. ml	Tolerance ± ml	Pack Size
77.504.0005	5	0.1	0.05	2
77.504.0010	10	0.2	0.1	2
77.504.0025	25	0.5	0.25	2
77.504.0050	50	1	0.5	2
77.504.0100	100	1	0.5	2
77.504.0250	250	2	1	2
77.504.0500	500	5	2.5	2
77.504.1000	1000	10	5	1
77.504.2000	2000	20	10	1

Measuring Cylinder, With Pour-out, Hexagonal Base, Class A With NABL Certificate

- Calibrated at 27°C
- In compliance to Class A DIN ISO 4788/IS 878 Standard
- Graduations in amber enamel
- Sturdy hexagonal base prevents roll-over and ensures greater stability
- NABL certificate is supplied with each unit



Cat. No.	Capacity ml	Sub-div. ml	Tolerance ± ml	Pack Size
72.504.0005	5	0.1	0.05	1
72.504.0010	10	0.2	0.1	1
72.504.0025	25	0.5	0.25	1
72.504.0050	50	1	0.5	1
72.504.0100	100	1	0.5	1
72.504.0250	250	2	1	1
72.504.0500	500	5	2.5	1
72.504.1000	1000	10	5	1
72.504.2000	2000	20	10	1

Best Seller



ISO
17025

Dish Washer
Durable
Print

Retrace
Code

ISO 4788
IS 878

Measuring Cylinder, USP Standard With Pour-out & Hexagonal Glass Base, Class A With Individual Works Certificate

- Calibrated at 20°C
- In compliance to ASTM E 1272
- Sturdy hexagonal base prevents roll-over and ensures greater stability
- A calibration certificate is provided with each Individual certified unit & same is available on our website



Cat. No.	Capacity	Sub-div.	Tolerance	Pack Size
	ml		ml	
50.522.0005	5	0.1	0.05	2
50.522.0010	10	0.2	0.1	2
50.522.0025	25	0.5	0.17	2
50.522.0050	50	1	0.25	2
50.522.0100	100	1	0.5	2
50.522.0250	250	2	1	2
50.522.0500	500	5	2	2
50.522.1000	1000	10	3	1
50.522.2000	2000	20	6	1



Measuring Cylinder, With Pour-out, Hexagonal Base Class B

- Calibrated at 27°C
- In compliance to Class B DIN ISO 4788/IS 878 Standard
- Graduations in amber enamel
- Sturdy hexagonal base prevents roll-over and ensures greater stability

Cat. No.	Capacity	Sub-div.	Tolerance	Pack Size
	ml		ml	
70.504.0005	5	0.1	0.1	2
70.504.0010	10	0.2	0.2	2
70.504.0025	25	0.5	0.5	2
70.504.0050	50	1	1	2
70.504.0100	100	1	1	2
70.504.0250	250	2	2	2
70.504.0500	500	5	5	2
70.504.1000	1000	10	10	1
70.504.2000	2000	20	20	1



Amber Colour Measuring Cylinders, With Spout, Hexagonal Base, Class A With Individual Works Certificate

- Calibrated at 27°C
- In compliance to Class 'A' DIN ISO 4788/IS 878 Standard
- Sturdy hexagonal base prevents roll-over and ensures greater stability
- Amber color is applied to reduce UV light Penetration
- A calibration certificate is provided with each Individual certified unit & same is available on our website

Cat. No.	Capacity	Sub-div.	Tolerance	Minimum Qty/Pack
	ml		ml	
75.504.0010	10	0.2	0.1	2
75.504.0025	25	0.5	0.25	2
75.504.0050	50	1	0.5	2
75.504.0100	100	1	0.5	2
75.504.0250	250	2	1	2

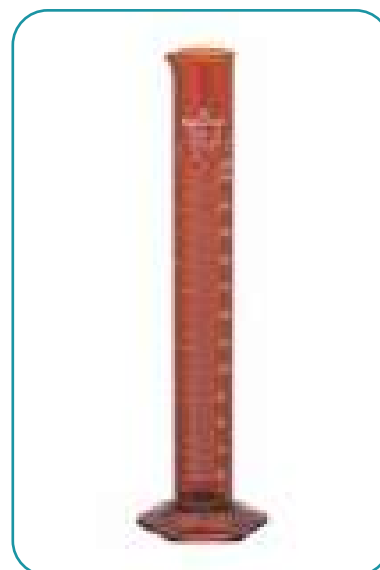

Measuring Cylinder, With Pour-out & Round Base, Class A With Individual Works Certificate

- Calibrated at 27°C
- In compliance to Class A DIN ISO 4788/IS 878 Standard
- Graduations in amber enamel
- A calibration certificate is provided with each Individual certified unit & same is available on our website

Cat. No.	Capacity ml	Sub-div. ml	Tolerance ± ml	Pack Size
77.502.0005	5	0.1	0.05	2
77.502.0010	10	0.2	0.1	2
77.502.0025	25	0.5	0.25	2
77.502.0050	50	1	0.5	2
77.502.0100	100	1	0.5	2
77.502.0250	250	2	1	2
77.502.0500	500	5	2.5	2
77.502.1000	1000	10	5	2
77.502.2000	2000	20	10	1

Measuring Cylinder, With Pour-out & Round Base, Class B

- Calibrated at 27°C
- In compliance to Class B DIN ISO 4788/IS 878 Standard
- Graduations in amber enamel

Cat. No.	Capacity ml	Sub-div. ml	Tolerance ± ml	Pack Size
70.502.0005	5	0.1	0.1	2
70.502.0010	10	0.2	0.2	2
70.502.0025	25	0.5	0.5	2
70.502.0050	50	1	1	2
70.502.0100	100	1	1	2
70.502.0250	250	2	2	2
70.502.0500	500	5	5	2
70.502.1000	1000	10	10	2
70.502.2000	2000	20	20	1

Measuring Cylinders, With Interchangeable Stopper, Hexagonal Base, Class A, With Individual Works Certificate.

- Calibrated at 27°C
- In compliance to Class A DIN ISO 4788/IS 878 Standard
- Graduations in amber enamel
- Sturdy hexagonal base prevents roll-over and ensures greater stability
- A calibration certificate is provided with each Individual certified unit & same is available on our website

Cat No.	Capacity, ml	Sub Div. ml	Tolerance ± ml	Pack Size
77.507.0005	5	0.1	0.05	2
77.507.0010	10	0.2	0.1	2
77.507.0025	25	0.5	0.25	2
77.507.0050	50	1	0.5	2
77.507.0100	100	1	0.5	2
77.507.0250	250	2	1	2
77.507.0500	500	5	2.5	2
77.507.1000	1000	10	5	1
77.507.2000	2000	20	10	1



Measuring Cylinders, With Interchangeable Stopper, Hexagonal Base, Class B

- Calibrated at 27°C
- In compliance to Class B DIN ISO 4788/IS 878 Standard
- Graduations in amber enamel
- Sturdy hexagonal base prevents roll-over and ensures greater stability

Cat No.	Capacity, ml	Sub Div. ml	Tolerance ± ml	Pack Size
70.507.0005	5	0.1	0.1	2
70.507.0010	10	0.2	0.2	2
70.507.0025	25	0.5	0.5	2
70.507.0050	50	1	1	2
70.507.0100	100	1	1	2
70.507.0250	250	2	2	2
70.507.0500	500	5	5	2
70.507.1000	1000	10	10	1
70.507.2000	2000	20	20	1



Measuring Cylinder Round Base, With Interchangeable Glass Stopper, Class A With Individual Works Certificate

- Calibrated at 27°C
- In compliance to Class A DIN ISO 4788/IS 878 Standard
- Graduations in Amber enamel
- A calibration certificate is provided with each Individual certified unit & same is available on our website

Cat. No.	Capacity ml	Sub-div. ml	Tolerance ± ml	Stopper Size	Pack Size
77.506.0010	10	0.2	0.1	10/19	2
77.506.0025	25	0.5	0.25	14/23	2
77.506.0050	50	1	0.5	14/23	2
77.506.0100	100	1	0.5	19/26	2
77.506.0250	250	2	1	24/29	2



Measuring Cylinder Round Base, With interchangeable Glass Stopper, Class B

- * Calibrated at 27°C
- * In compliance to Class B DIN ISO 4788/IS 878 Standard
- * Graduations in amber enamel

Cat. No.	Capacity ml	Sub-div. ml	Tolerance ± ml	Stopper Size	Pack Size
70.506.0005	5	0.1	0.1	10/19	2
70.506.0010	10	0.2	0.2	10/19	2
70.506.0025	25	0.5	0.5	14/23	2
70.506.0050	50	1	1	14/23	2
70.506.0100	100	1	1	19/26	2
70.506.0250	250	2	2	24/29	2
70.506.0500	500	5	5	24/29	2
70.506.1000	1000	10	10	29/32	2



Nessler Cylinder In Compliance With IS 4161:1967 For Colour Comparison

Cat. No.	Capacity ml	Sub-div. ml	Pack Size
70.508.0050	50	25 & 50	2
70.508.0100	100	50 & 100	2

Nessler Cylinder, In Compliance With IS 4161:1967 For Colour Comparison, Class 'A' With Individual Works Certificate

Cat. No.	Capacity ml	Sub-div. ml	Tolerance \pm ml	Pack Size
77.508.0050	50	25 & 50	0.4	2
77.508.0100	100	50 & 100	0.8	2

Nessler Cylinder, For Colour Comparison, With Interchangeable Stopper, Graduated as per IS 4161 : 1967, Class 'A' With Individual Works Certificate

Cat No.	Capacity ml	Sub-div. ml	Tolerance \pm ml	Stopper Size	Pack Size
77.515.0050	50	25 to 50	0.4	19/26	2
77.515.0100	100	50 & 100	0.8	19/26	2

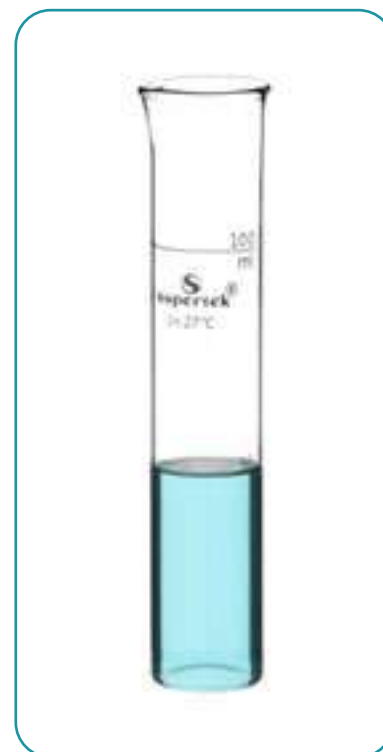

Cones, Imhoff, Sediment, Sharp Tip, Graduated From 0 To 1 ml in 0.1 ml. Division, 1 to 10 ml. In 0.5 ml. and 10 to 40 ml. In 1 ml. Also Marked At 1000 ml. Approx. Total Height 454 Mm., Approx. Top Dia 100 mm

Cat No.	Pack Size
79.527.0010	1

Cones, Imhoff, Sediment, Blunt Tip, Graduated From 0 To 1 ml In 0.1 ml. Division, 1 To 10 ml. In 0.5 ml. And 10 To 40 ml in 1 ml., Approx. Top Dia 100 mm.

Cat No.	Pack Size
79.527.0020	1

Stand For Cones, Imhoff

Cat No.	Pack Size
79.527.0030	1



Interchangeable Glassware



**Vital Connections for your Complex Assemblies -
Supertek IC Glassware**

Interchangeable Glassware

Socket Single, Medium Length

• Conformity to ISO 383/DIN 12249 Standards

Cat No.	Socket size	Approx. o.d. of tube, mm	Total length, mm	Pack Size
14.101.0005	7/16	10	120±10	12
14.101.0010	10/19	13	120±10	12
14.101.0015	12/21	16	120±10	12
14.101.0020	14/23	18	120±10	12
14.101.0025	19/26	22	120±15	12
14.101.0030	24/29	28	120±15	12
14.101.0035	29/32	32	120±15	12
14.101.0040	34/35	38	120±15	12
14.101.0045 *	40/38	45	120±15	12
14.101.0050	45/40	50	120±15	12
14.101.0055 *	50/42	55	120±15	12
14.101.0060 *	55/44	60	120±15	12

*Non DIN size



Cone Single, Medium Length

• Conformity to ISO 383/DIN 12249 Standards

Cat No.	Cone size	Approx. o.d. of tube, mm	Total length, mm	Pack Size
14.104.0005	7/16	6	120±10	12
14.104.0010	10/19	8	120±10	12
14.104.0015	12/21	9	120±10	12
14.104.0020	14/23	13	120±10	12
14.104.0025	19/26	16	120±15	12
14.104.0030	24/29	22	120±15	12
14.104.0035	29/32	26	120±15	12
14.104.0040	34/35	30	120±15	12
14.104.0045 *	40/38	36	120±15	12
14.104.0050	45/40	40	120±15	12
14.104.0055 *	50/42	45	120±15	12
14.104.0060 *	55/44	50	120±15	12

*Non DIN size

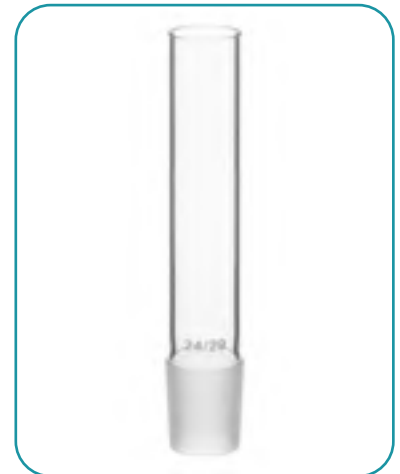

Socket, Double (One At Each End)

• Conformity to ISO 383/DIN 12249 Standards

Cat No.	Socket size	Approx. o.d. of tube, mm	Total length, mm	Pack Size
14.120.0005 *	7/16	11	135±2	12
14.120.0010 *	10/19	14	135±2	12
14.120.0015	14/23	18	135±2	12
14.120.0020	19/26	22	140±2	12
14.120.0025	24/29	28	170±5	12
14.120.0030	29/32	32	170±5	12
14.120.0040	34/35	38	180±5	12

*Non DIN size



ISO
383

DIN
12249

Cone, Double (One At Each End)

• Conformity to ISO 383/DIN 12249 Standards

Cat No.	Cone size	Approx. o.d. of tube, mm	Total length, mm	Pack Size
14.124.0005 *	10/19	8	90±5	12
14.124.0010	14/23	13	90±5	12
14.124.0015	19/26	16	90±5	12
14.124.0020	24/29	22	110±10	12
14.124.0025	29/32	26	110±10	12
14.124.0030	34/35	30	120±10	12

*Non DIN size



Spherical Joint, Ball

• Conformity to DIN 12264 Standards

Cat No.	Cup joint male	Min. Shank length, mm	Pack Size
14.128.0010	S13	100	12
14.128.0015	S19	100	12
14.128.0020	S29	100	12
14.128.0025	S35	100	12
14.128.0030	S41	100	12



Spherical Joint, Cup

• Conformity DIN 12264 Standards

Cat No.	Cup joint female	Min. Shank length, mm	Pack Size
14.132.0010	S13	100	12
14.132.0015	S19	100	12
14.132.0020	S29	100	12
14.132.0025	S35	100	12
14.132.0030	S41	100	12



Joint Clip, Metal

- Manufactured from corrosion resistant stainless steel metal
- Used for retaining of spherical joints

Cat No.	To Fit Spherical Joint Size	Pack Size	
14.136.0005	S13	10	
14.136.0010	S19	10	
14.136.0015	S29	10	
14.136.0020	S35	10	
14.136.0025	S41	10	



Joint Clip, PP

- Autoclavable

Cat No.	To Fit Conical Joint Size	Pack Size	
14.140.0005	14/23	50	
14.140.0010	19/26	50	
14.140.0015	24/29	50	
14.140.0020	29/32	50	
14.140.0025	34/35	50	

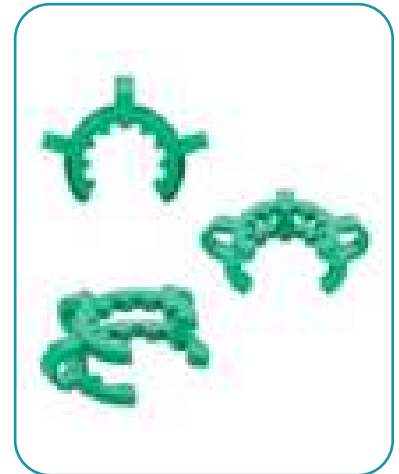

Stopper, Hollow, Hexagonal Head

- Conformity to DIN 12252 Standard

Cat. No.	Cone Size	Pack Size	
14.201.0005	10/19	12	
14.201.0010	12/21	12	
14.201.0015	14/23	12	
14.201.0020	19/26	12	
14.201.0025	24/29	12	
14.201.0030	29/32	12	
14.201.0035	34/35	12	



DIN
12252

Stopper, Glass, Amber Hollow, Hexagonal Head

• Conformity to DIN 12252 Standards

Cat. No.	Cone	Pack Size
14.203.0005	10/19	20
14.203.0010	12/21	20
14.203.0015	14/23	20
14.203.0020	19/26	20
14.203.0025	24/29	10
14.203.0030	29/32	10
14.203.0035	34/35	10



DIN 12252

Stopper, Solid, Penny Head-Long Neck Flasks

Cat. No.	Flask Capacity	Cone	Pack Size
14.204.0005	Upto 25 ml	10/19	12
14.204.0006	50 ml	12/21	12
14.204.0010	100, 200,250 ml	14/23	12
14.204.0015	500 ml	19/26	12
14.204.0020	1000 ml	24/29	12
14.204.0025 *	2000 ml	29/32	12
14.204.0030 *	5000 ml	34/35	12



Stopper, Amber, Solid, Penny Head-Long Neck Flasks

Cat. No.	Flask Capacity	Cone	Pack Size
14.207.0005	Upto 25 ml	10/19	12
14.207.0006	50 ml	12/21	12
14.207.0010	100, 200,250 ml	14/23	12
14.207.0015	500 ml	19/26	12
14.207.0020	1000 ml	24/29	12
14.207.0025 *	2000 ml	29/32	12
14.207.0030 *	5000 ml	34/35	12



Stopper, Solid, Flat Head For Reagent Bottles

Cat. No.	Cone	Pack Size
14.205.0005	14/23	12
14.205.0010	19/26	12
14.205.0015	24/29	12
14.205.0020	29/32	12
14.205.0025	34/35	12



Stopper, Amber, Solid, Flat Head For Reagent Bottles

Cat. No.	Cone	Pack Size
14.212.0005	14/23	12
14.212.0010	19/26	12
14.212.0015	24/29	12
14.212.0020	29/32	12
14.212.0025	34/35	12



Super Stopper™, Spare Stoppers for Long Neck Flask

- Conformity to DIN 12254 Standard

Cat. No.	Flask Capacity	Cone	Pack Size
14.215.0005	Upto 25 ml	10/19	20
14.215.0010	50 ml	12/21	20
14.215.0015	100, 200, 250 ml	14/23	20
14.215.0020	500 ml	19/26	20
14.215.0025	1000 ml	24/29	10
14.215.0030	2000 ml	29/32	10



DIN
12254

Reduction Adapter

- Conformity to DIN 12257 Standard

Cat No.	Socket size	Cone size	Pack Size
14.301.0005 *	14/23	14/23	12
14.301.0010	14/23	19/26	12
14.301.0015 *	14/23	24/29	12
14.301.0020	14/23	29/32	12
14.301.0025	19/26	24/29	12
14.301.0030	19/26	29/32	12
14.301.0035	19/26	34/35	12
14.301.0040	19/26	40/38	12
14.301.0045	19/26	45/40	12
14.301.0050	19/26	55/44	12
14.301.0055 *	24/29	29/32	12
14.301.0060 *	24/29	34/35	12
14.301.0065 *	24/29	40/38	12
14.301.0070 *	24/29	45/40	12
14.301.0075 *	24/29	50/42	12
14.301.0080 *	24/29	55/44	12
14.301.0085	29/32	34/35	12
14.301.0090	29/32	40/38	12
14.301.0095	29/32	45/40	12
14.301.0100 *	34/35	40/38	12
14.301.0105 *	34/35	45/40	12
14.301.0110 *	34/35	50/42	12

*Non DIN size



Expansion Adapter

- Conformity to DIN 12257 Standard

Cat No.	Socket size	Cone size	Pack Size
14.304.0005	19/26	14/23	12
14.304.0010 *	24/29	14/23	12
14.304.0015 *	24/29	19/26	12
14.304.0020	29/32	14/23	12
14.304.0025	29/32	19/26	12
14.304.0030 *	29/32	24/29	12
14.304.0035 *	34/35	19/26	12
14.304.0040 *	34/35	24/29	12
14.304.0045 *	34/35	29/32	12
14.304.0050 *	40/38	24/29	12
14.304.0055 *	45/40	29/32	12

*Non DIN size



Multiple Adapter. With Two Necks Parallel

- Conformity to DIN 12594

Cat No.	Socket size	Cone size	Pack Size
14.312.0005	14/23	14/23	1
14.312.0010 *	14/23	19/26	1
14.312.0015	19/26	19/26	1
14.312.0020 *	19/26	24/29	1
14.312.0025 *	24/29	24/29	1
14.312.0030 *	19/26	34/35	1
14.312.0035	29/32	29/32	1

*Non DIN size



Multiple Adapter, With Two Necks, One Vertical & One At 45°

Cat No.	Socket Size	Cone Size	Pack Size
14.316.0005	14/23	14/23	1
14.316.0010	14/23	19/26	1
14.316.0015	14/23	24/29	1
14.316.0020	19/26	19/26	1
14.316.0025	19/26	24/29	1
14.316.0030	14/23	29/32	1
14.316.0035	29/32	29/32	1



Multiple Adapter, With Three Necks, Two Parallel & One At 45°

Cat No.	Vertical Socket Size	Inclined Socket Size	Cone Size	Pack Size
14.320.0005	19/26	19/26	19/26	1
14.320.0010	19/26	19/26	24/29	1
14.320.0015	14/23	14/23	29/32	1
14.320.0020	19/26	19/26	29/32	1
14.320.0025	29/32	29/32	29/32	1
14.320.0030	24/29	24/29	24/29	1
14.320.0032	19/26	19/26	34/35	1



Swan Neck Adapter With Screw Thread, For Use With Thermometer Or Air Leak Tube

Cat No.	Socket Size	Cone Size	Pack Size
14.324.0005	14/23	19/26	1
14.324.0010	19/26	19/26	1
14.324.0015	19/26	24/29	1
14.324.0020	24/29	24/29	1
14.324.0025	29/32	29/32	1



Receiver Delivery Adapter - Short Stem

Cat No.	Socket Size	Approx. Length, mm	Pack Size
14.336.0005	14/23	65	1
14.336.0010	19/26	65	1
14.336.0015	24/29	65	1
14.336.0020	29/32	65	1



Receiver Delivery Adapter - Long Stem

Cat No.	Socket size	Approx. Length, mm	Pack Size
14.340.0005	14/23	190	1
14.340.0010	19/26	200	1
14.340.0015	24/29	200	1
14.340.0020	29/32	200	1



Receiver Adapter - Straight Delivery

Cat No.	Socket size	Pack Size
14.344.0005	14/23	10
14.344.0010	19/26	10
14.344.0015	24/29	10
14.344.0020	29/32	10



Receiver Adapter - Plain Bend

Cat No.	Socket size	Cone size	Pack Size
14.348.0005	14/23	14/23	1
14.348.0010	14/23	19/26	1
14.348.0015	19/26	19/26	1
14.348.0020	19/26	24/29	1
14.348.0025	24/29	24/29	1
14.348.0030	29/32	29/32	1



Receiver Adapter - Bend With Vent

Cat No.	Socket size	Cone size	Pack Size
14.352.0005	14/23	14/23	1
14.352.0010	19/26	19/26	1
14.352.0015	19/26	24/29	1
14.352.0020	24/29	24/29	1
14.352.0025	29/32	29/32	1



Receiver Adapter With Vacuum Connection, Bend Type

• In conformity to DIN 12594

Cat No.	Socket size	Cone size	Pack Size
14.355.0005	14/23	14/23	1
14.355.0010*	14/23	19/26	1
14.355.0015	19/26	19/26	1
14.355.0020*	19/26	24/29	1
14.355.0025*	24/29	24/29	1
14.355.0030*	24/29	29/32	1
14.355.0035	29/32	29/32	1

*Non DIN



DIN 12594

Receiver Adapter With Vacuum Connection, Straight Type

• In conformity to DIN 12594

Cat No.	Socket size	Cone size	Pack Size
14.356.0005	14/23	14/23	1
14.356.0010*	14/23	19/26	1
14.356.0015	19/26	19/26	1
14.356.0020*	19/26	24/29	1
14.356.0025*	24/29	24/29	1
14.356.0030*	24/29	29/32	1
14.356.0035	29/32	29/32	1

*Non DIN



DIN 12594

Receiver Adapter, Socket To Cone, With Vertical Socket

Cat No.	Socket size	Cone size	Pack Size
14.360.0005	14/23	14/23	1
14.360.0010	19/26	19/26	1
14.360.0015	19/26	24/29	1
14.360.0020	24/29	24/29	1
14.360.0025	29/32	29/32	1



Receiver Adapter, With Multiple Connection

Cat No.	Socket Size	Cone Size	Pack Size
14.364.0005	14/23	14/23	1
14.364.0010	14/23	19/26	1
14.364.0015	19/26	19/26	1



Recovery Bend, Sloping

Cat No.	Cone Size to fit flask	Cone Size to fit condenser	Pack Size
14.368.0005	14/23	14/23	1
14.368.0010	24/29	14/23	1
14.368.0015	19/26	19/26	1
14.368.0020	24/29	19/26	1
14.368.0025	29/32	19/26	1
14.368.0030	29/32	29/32	1
14.368.0035	24/29	24/29	1
14.368.0040	34/35	24/29	1
14.368.0045	29/32	24/29	1
14.368.0050	34/35	34/35	1



Recovery Bend, Vertical

Cat No.	Cone Size to fit flask	Cone Size to fit condenser	Pack Size
14.372.0005	14/23	14/23	1
14.372.0010	19/26	19/26	1
14.372.0015	24/29	19/26	1
14.372.0020	24/29	24/29	1
14.372.0025	29/32	29/32	1



Still Head, Plain With Thermometer Socket

Cat No.	Socket Size	Cone Size to fit flask	Cone Size to fit condenser	Pack Size
14.376.0005	14/23	14/23	14/23	1
14.376.0010	14/23	19/26	19/26	1
14.376.0015	14/23	24/29	19/26	1
14.376.0020	14/23	29/32	19/26	1
14.376.0025	14/23	34/35	19/26	1
14.376.0030	14/23	24/29	24/29	1
14.376.0035	14/23	34/35	24/29	1
14.376.0040	14/23	29/32	24/29	1
14.376.0045	14/23	29/32	29/32	1
14.376.0050	14/23	34/35	29/32	1

Claisen Head, Sloping, With Two 14/23 Sockets

Cat No.	Socket Size	Cone Size to fit flask	Cone Size to fit condenser	Pack Size
14.380.0005	14/23	14/23	14/23	1
14.380.0010	14/23	19/26	19/26	1
14.380.0015	14/23	24/29	19/26	1
14.380.0020	14/23	24/29	24/29	1
14.380.0025	14/23	29/32	29/32	1
14.380.0030	14/23	34/35	24/29	1

Splash Head Adapters, for Rotavaps Anticlamp without return hole.

Cat. No.	Bulb Cap. ml.	Socket Size	Cone Size	Pack Size
14.382.0100	100	29/32	14/23	1
14.382.0250	250	29/32	19/26	1
14.382.0500	500	29/32	24/29	1



Splash Head Adapter, Pear Shape, Straight

Cat No.	Socket to fit flask	Cone to fit condenser	Pack Size
14.384.0005	14/23	14/23	1
14.384.0010	19/26	24/29	1
14.384.0015	29/32	29/32	1



Splash Head, Pear Shape, Vertical

Cat No.	Cone to fit flask	Cone to fit condenser	Pack Size
14.388.0005	14/23	14/23	1
14.388.0010	19/26	19/26	1
14.388.0015	24/29	19/26	1
14.388.0020	24/29	24/29	1
14.388.0025	29/32	29/32	1



Splash Head, Pear Shape, Sloping

Cat No.	Cone to fit flask	Cone to fit condenser	Pack Size
14.392.0005	14/23	14/23	1
14.392.0010	19/26	19/26	1
14.392.0015	24/29	19/26	1
14.392.0020	24/29	24/29	1
14.392.0025	29/32	29/32	1



Steam Distillation Head, Sloping

Cat No.	Cone to fit flask	Cone to fit condenser	Pack Size
14.396.0005	24/29	19/26	1
14.396.0010	34/35	19/26	1
14.396.0015	34/35	24/29	1



Adapter, Cone To Flexible Tubing Right Angle Connection With Screw Thread

Cat No.	Cat No.	Socket Size	Pack Size
STRAIGHT B	RIGHT ANGLE A		
14.399.0005	14.400.0005	14/23	1
14.399.0010	14.400.0010	19/26	1
14.399.0015	14.400.0015	24/29	1
14.399.0020	14.400.0020	29/32	1



Adapter, Cone To Flexible Tubing, Straight Connection With Glass Stopcock

Cat No.	Cone	Pack Size
14.404.0005	14/23	1
14.404.0010	19/26	1
14.404.0015	24/29	1
14.404.0020	29/32	1

(Also available with PTFE key & Needle Valve stopcock on request. Please ask for prices)



Adapter, Cone To Flexible Tubing, Right Angle Connection With Glass Stopcock

Cat No.	Cone	Pack Size
14.408.0005	14/23	1
14.408.0010	19/26	1
14.408.0015	24/29	1
14.408.0020	29/32	1

(Also available with PTFE key & Needle Valve stopcock on request. Please ask for prices)

Adapter, Socket To Flexible Tubing, Straight Connection With Glass Stopcock

Cat No.	Socket	Pack Size
14.412.0005	14/23	1
14.412.0010	19/26	1
14.412.0015	24/29	1
14.412.0020	29/32	1

(Also available with PTFE key & Needle Valve stopcock on Request. Please ask for prices)

Adapter, Socket To Flexible Tubing, Right Angle Connection With Glass Stopcock

Cat No.	Socket	Pack Size
14.416.0005	14/23	1
14.416.0010	19/26	1
14.416.0015	24/29	1
14.416.0020	29/32	1

(Also available with PTFE key & Needle Valve stopcock on Request. Please ask for prices)



Adapter, Cone With Stem To Flexible Tubing Right Angle Connection

Cat No.	Cone	Pack Size
14.420.0005	14/23	1
14.420.0010	19/26	1
14.420.0015	24/29	1
14.420.0020	29/32	1



Adapter, Socket To Flexible Tubing Straight Connection

Cat No.	Socket Size	Pack Size
14.424.0005	14/23	1
14.424.0010	19/26	1
14.424.0015	24/29	1
14.424.0020	29/32	1



Adapter, Socket To Cone With Side Arm And Screw Thread

Cat No.	Socket size	Cone size	Pack Size
14.428.0005	14/23	14/23	1
14.428.0010	14/23	19/26	1
14.428.0015	14/23	24/29	1
14.428.0020	14/23	29/32	1
14.428.0025	19/26	19/26	1
14.428.0030	19/26	24/29	1
14.428.0035	19/26	29/32	1
14.428.0040	24/29	24/29	1
14.428.0045	24/29	29/32	1
14.428.0050	29/32	29/32	1



U Tube With Two Sockets

Cat No.	Socket Size	Pack Size
14.432.0005	14/23	10
14.432.0010	19/26	10

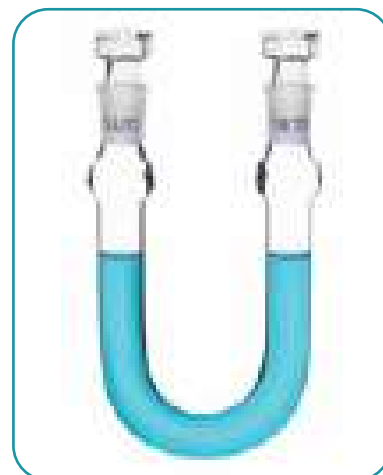

Drying Tube

Cat No.	Cone Size	Pack Size
14.436.0005	14/23	10
14.436.0010	19/26	10
14.436.0015	24/29	10
14.436.0020	29/32	10



Thermometer Pocket

Cat No.	Cone Size	Approx Stem Length, mm	Pack Size
14.440.0005	14/23	45	10
14.440.0010	19/26	45	10
14.440.0015	24/29	45	10

Thermometer Pocket, Long type, for sealing to required length.

Cat No.	Cone Size	Pack Size
14.442.0005	14/23	6
14.442.0010	19/26	6
14.442.0015	24/29	6
14.442.0020	34/35	6



Air Leak Tube/Gas Inlet Tube

Cat No.	Cone Size	Pack Size
14.444.0005	14/23	10
14.444.0010	19/26	10
14.444.0015	24/29	10
14.444.0020	29/32	10



Adapter Cone Screw Thread

Cat No.	To fit stirrer	Cone Size	Pack Size
14.448.0005	6 mm	14/23	10
14.448.0010	6 mm	19/26	10
14.448.0015	6 mm	24/29	10
14.448.0020	6 mm	29/32	10



Glass Stirring Rods

Cat No.	Approx OD x Length mm	Pack Size
15.320.0815	8 x 150	20
15.320.0820	8 x 200	20
15.320.0825	8 x 250	20
15.320.0830	8 x 300	20
15.320.1015	10 x 150	20
15.320.1020	10 x 200	20
15.320.1025	10 x 250	20
15.320.1030	10 x 300	20

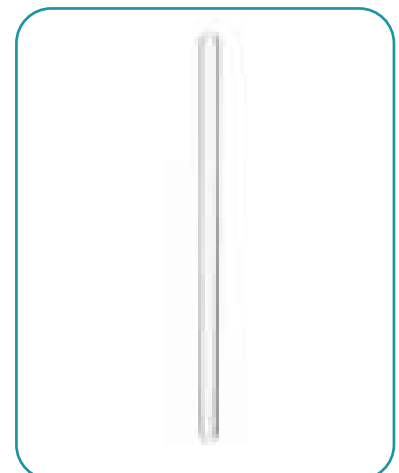

Teflon Bladed Stirrers, Blade Removable from the Stirrer Shaft

Cat No.	Approx. shaft dia. mm.	Shaft Length mm.	Smallest Socket through which blade will pass	Blade width mm.	Pack Size
14.463.0005	6	450	19/26	52	2
14.463.0010	6	450	24/29	76	2
14.463.0015	8	450	24/29	76	2
14.463.0020	8	450	29/32	100	2
14.463.0025	8	600	34/35	100	2
14.463.0030	10	450	34/35	100	2
14.463.0035	10	600	34/35	125	2
Shaft for Teflon Bladed Stirrers					
14.463.0040	6	450			2
14.463.0045	8	450			2
14.463.0050	8	600			2
14.463.0055	10	450			2
14.463.0060	10	600			2

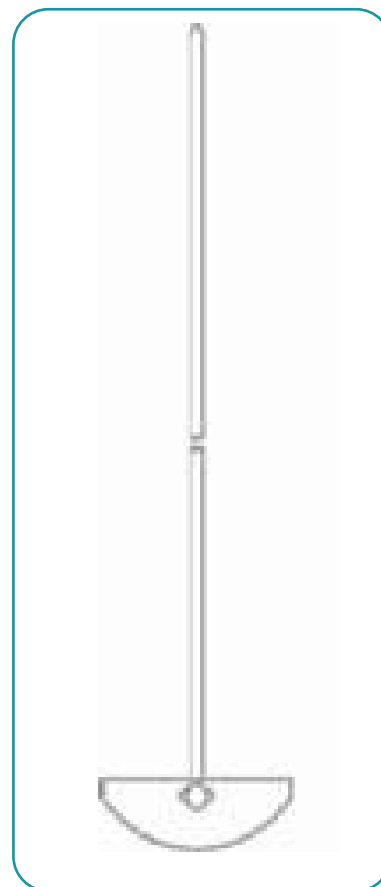



Vortex Mixer

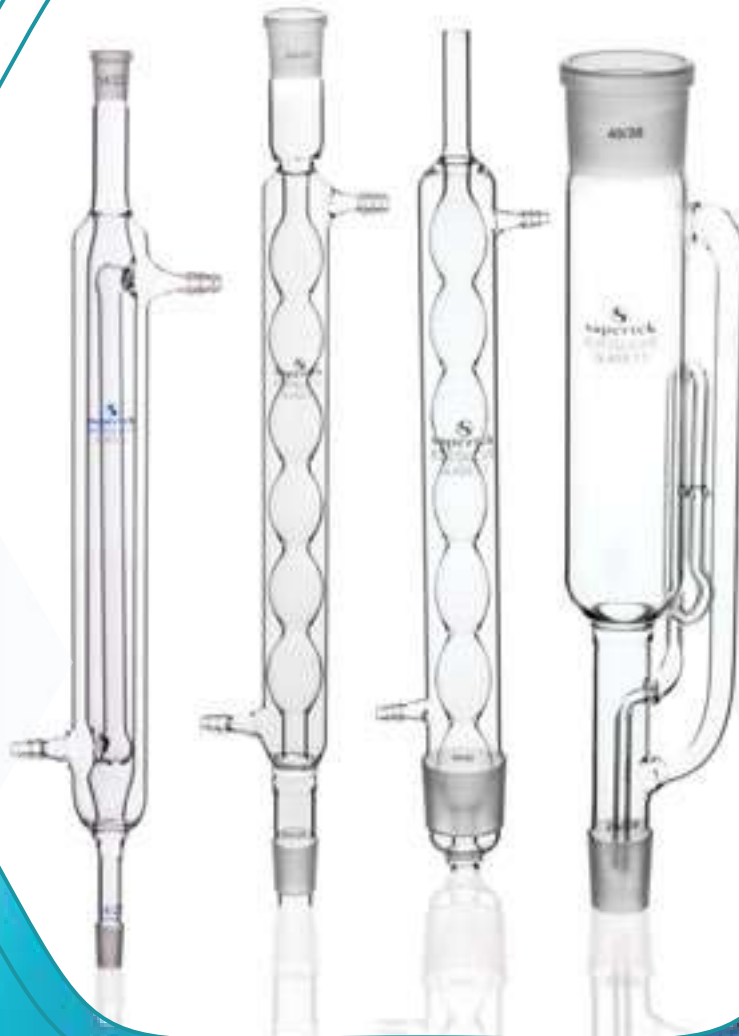

See Page No. 183

Condensers



**Effective Cooling during Distillation & Extractions ?
Depend on Supertek Range of Condensers**

Condensers

supertek® brand condensers are manufactured from low-expansion Boro 3.3 Glass as per ASTM E-438 Type-1 standard and DIN ISO 3585. These condensers have a standard taper joint with drip tip.

A condenser is used to facilitate the cooling of hot vapors and liquids. It consists of a bigger glass tube, containing a smaller glass tube running through its length. Hot liquids pass through this smaller glass tube.

Usually, the outer glass tube has two tube connections to aid the passing of a coolant (usually water or anti-freeze mixture). The coolant goes inside through the lower connection, while the upper connection serves as the outlet.

Multiple condensers may be connected in a series.

NOTE : All condensers can be supplied with different joint sizes as per requirement

supertek® offers you the choice of a wide range of Condensers.

Condenser, Air

Cat. No.	Effective Length, mm	Socket Size	Cone Size	Pack Size
16.101.0005	200	14/23	14/23	1
16.101.0010	200	19/26	19/26	1
16.101.0015	250	24/29	24/29	1
16.101.0020	400	19/26	19/26	1
16.101.0023	400	24/29	24/29	1
16.101.0025	500	24/29	24/29	1
16.101.0030	500	34/35	34/35	1
16.101.0035	600	19/26	19/26	1
16.101.0040	750	24/29	24/29	1
16.101.0045	750	-	19/26	1
16.101.0050	750	.	24/29	1
16.101.0055	1000	-	19/26	1
16.101.0060	1000	-	24/29	1

NOTE : All condensers can be supplied with different joint sizes as per requirement

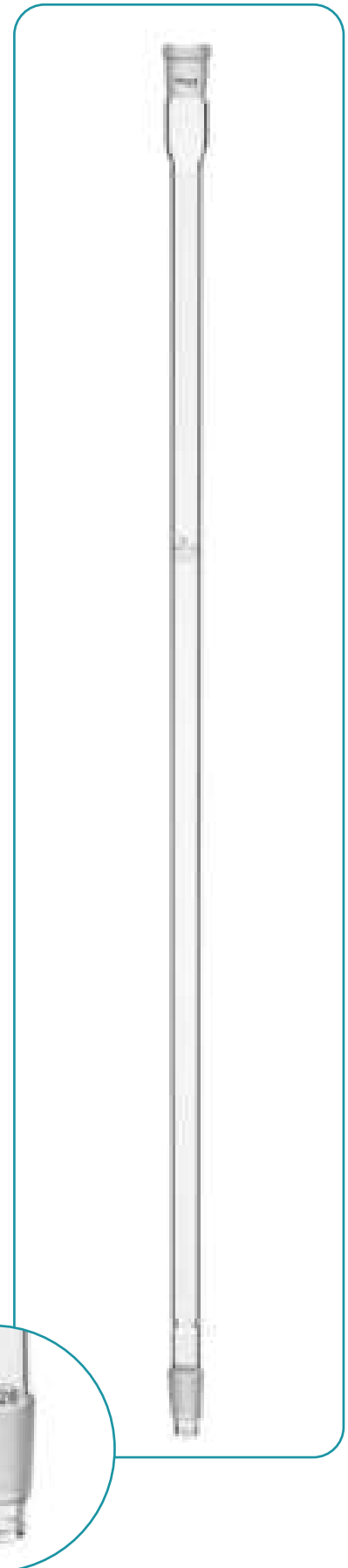

Liebig condensers have a basic fluid circulating design. It consists of an inner straight tube and an outer tube having connector for fluid inflow and outflow.

Condenser, Liebig

Conformity to DIN 12576 Standard

Cat. No.	Effective Length, mm	Socket Size	Cone Size	Pack Size
16.104.0035	160	14/23	14/23	1
16.104.0036*	200	19/15	19/15	1
16.104.0037	200	19/26	19/26	1
16.104.0038	200	24/29	24/29	1
16.104.0040	250	19/26	19/26	1
16.104.0045	250	24/29	24/29	1
16.104.0050	250	29/32	29/32	1
16.104.0051*	300	19/15	19/15	1
16.104.0052	300	19/26	19/26	1
16.104.0055 *	300	24/29	24/29	1
16.104.0060 *	300	29/32	29/32	1
16.104.0063	350	19/26	19/26	1
16.104.0067	350	24/29	24/29	1
16.104.0070	350	29/32	29/32	1
16.104.0072*	400	19/15	19/15	1
16.104.0075 *	400	19/26	19/26	1
16.104.0080	400	24/29	24/29	1
16.104.0085	400	29/32	29/32	1
16.104.0090	450	19/26	19/26	1
16.104.0095	450	24/29	24/29	1
16.104.0097*	500	19/15	19/15	1
16.104.0100	500	24/29	24/29	1
16.104.0105	500	29/32	29/32	1
16.104.0115	600	24/29	24/29	1
16.104.0120	750	24/29	24/29	1
16.104.0125	500	34/35	34/35	1
16.104.0130	600	34/35	34/35	1
16.104.0140	750	34/35	34/35	1
16.104.0150	900	34/35	34/35	1
16.104.0155	300	-	19/26	1
16.104.0160	350	-	24/29	1
16.104.0165	250	-	34/35	1

*Non DIN Size

NOTE : All condensers can be supplied with different joint sizes as per requirement



Glass Connector

Condenser, Coil, Graham, Coil Distillate Type **A**

- The coiled condensation tubes provide greater surface area for cooling
- Designed with standard joints providing universal fitting

Cat. No.	Effective Length, mm	Socket Size	Cone Size	Pack Size
16.108.0025	160	14/23	14/23	1
16.108.0030	200	19/26	19/26	1
16.108.0035	250	19/26	19/26	1
16.108.0040	250	24/29	24/29	1
16.108.0045	300	19/26	19/26	1
16.108.0050	300	24/29	24/29	1
16.108.0055	400	24/29	24/29	1
16.108.0060	500	24/29	24/29	1
16.108.0065	500	34/35	34/35	1
16.108.0070	600	34/35	34/35	1

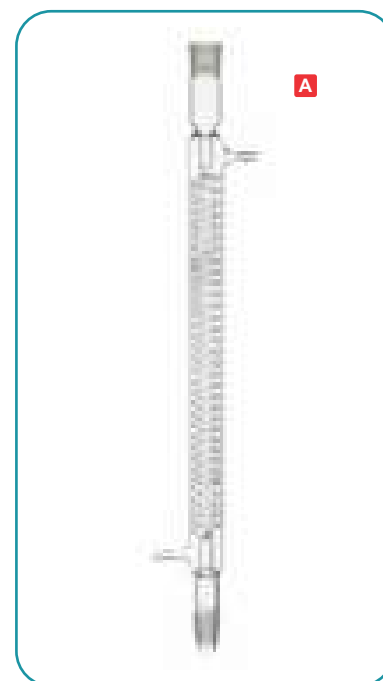

Condenser, Coil, Graham, Jacket Distillate Type **B**

- The coiled condensation tubes provide greater surface area for cooling
- Designed with standard joints providing universal fitting

Cat. No.	Effective Length, mm	Socket Size	Cone Size	Pack Size
16.112.0025	160	14/23	14/23	1
16.112.0028	160	29/32	29/32	1
16.112.0030	200	19/26	19/26	1
16.112.0035	250	19/26	19/26	1
16.112.0040	250	24/29	24/29	1
16.112.0045	300	19/26	19/26	1
16.112.0050	300	24/29	24/29	1
16.112.0052	300	29/32	29/32	1
16.112.0055	400	24/29	24/29	1



NOTE : All condensers can be supplied with different joint sizes as per requirement

Condenser, Coil, Reversible

- Designed with standard joints providing universal fitting

Cat. No.	Effective Length, mm	Socket Size	Cone Size	Pack Size
16.116.0005	160	-	19/26 & 24/29	1
16.116.0010	160	-	24/29 & 24/29	1
16.116.0015	160	-	24/29 & 34/35	1



Condenser, Double Coil, With Common Inlet

- Features a double coil design with a common water inlet
- Suitable for pilot plant work

Cat. No.	Effective Length, mm	Socket Size	Cone Size	Pack Size
16.120.0005	200	19/26	19/26	1
16.120.0010	200	24/29	24/29	1
16.120.0015	350	34/35	34/35	1
16.120.0020	450	34/35	34/35	1
16.120.0025	600	34/35	34/35	1



NOTE : All condensers can be supplied with different joint sizes as per requirement

Condenser, Double Surface, Davies

- These condensers are majorly used in research laboratories. A double-surface condenser has a water jacket both on the outside and through the center of the condensing tube. It is required where the condenser liquid is very volatile. Hence for distilling ethers, alcohols, esters, aromatics, petroleum products, and essential oils these condensers are widely used.

Cat. No.	Effective Length, mm	Socket Size	Cone Size	Pack Size
16.124.0010	150	19/26	19/26	1
16.124.0015	150	24/29	24/29	1
16.124.0020	200	19/26	19/26	1
16.124.0025	200	24/29	24/29	1
16.124.0030	200	29/32	29/32	1
16.124.0035	200	-	19/26	1
16.124.0040	200	-	24/29	1
16.124.0045	200	-	34/35	1
16.124.0050	250	-	19/26	1
16.124.0055	250	19/26	19/26	1
16.124.0060	250	24/29	24/29	1
16.124.0065	300	19/26	19/26	1
16.124.0070	300	24/29	24/29	1
16.124.0075	400	24/29	24/29	1
16.124.0080	500	24/29	24/29	1
16.124.0085	500	34/35	34/35	1
16.124.0090	600	34/35	34/35	1



Condenser, Jacketed Coil, Double Surface Condenser

- Double surface condensers with a coil as the inner surface provides approximately twice the surface area of plain coil condensers of the same effective length.

Cat. No.	Effective Length, mm	Socket Size	Cone Size	Pack Size
16.128.0005	160	19/26	19/26	1
16.128.0010	160	24/29	24/29	1
16.128.0012	160	29/32	29/32	1
16.128.0015	160	-	34/35	1
16.128.0020	160	-	40/38	1
16.128.0025	200	19/26	19/26	1
16.128.0030	200	24/29	24/29	1
16.128.0035	300	19/26	19/26	1
16.128.0040	300	24/29	24/29	1
16.128.0045	400	24/29	24/29	1
16.128.0050	400	34/35	34/35	1
16.128.0055	500	34/35	34/35	1

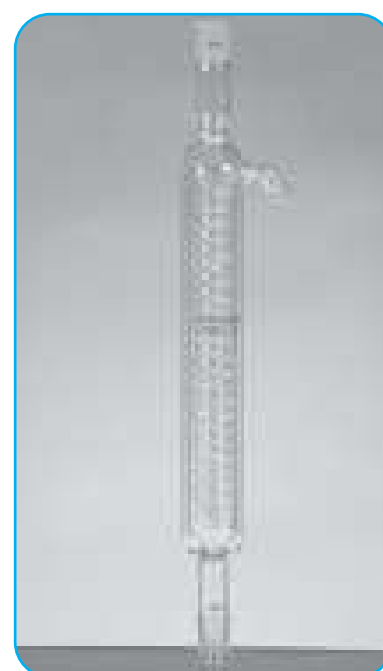

Condenser, Inland Revenue

- Inland Revenue Pattern
- Highly efficient
- Vapour and distillate move down through the coil
- Coolant water flows outside the coil

Cat. No.	Effective Length, mm	Socket Size	Cone Size	Pack Size
16.132.0010	200	19/26	19/26	1
16.132.0015	200	24/29	24/29	1



Condenser, Allihn (Bulb Condenser)

- Conformity to DIN 12581
- Better surface area than the Liebig Condenser. Series of bulbs provide higher cooling capacity which is ideal for reflux applications
- Designed with standard joints providing universal fitting.

Cat. No.	Effective Length, mm	Socket Size	Cone Size	Pack Size
16.136.0025	200	-	19/26	1
16.136.0030	200	-	24/29	1
16.136.0035	200	-	29/32	1
16.136.0040	200	-	34/35	1
16.136.0045	200	-	40/38	1
16.136.0050	200	-	50/42	1
16.136.0055	250	-	50/42	1
16.136.0060	200	19/26	19/26	1
16.136.0065	200	24/29	24/29	1
16.136.0070	300	19/26	19/26	1
16.136.0075	300	24/29	24/29	1
16.136.0080	400	24/29	24/29	1
16.136.0085	500	24/29	24/29	1
16.136.0090	500	34/35	34/35	1
16.136.0095	600	34/35	34/35	1
16.136.0100	750	34/35	34/35	1

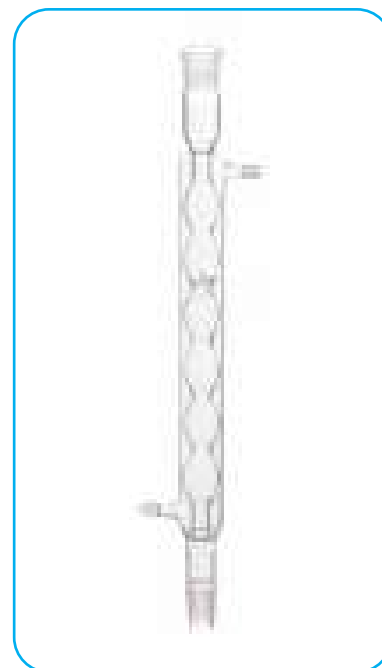

NOTE : All condensers can be supplied with different joint sizes as per requirement

Condenser, Friedrich

- Specially designed inner spiral tubes ensure a long vapour path
- Offer better heat transfer
- Condenser has a standard taper outer joint and a lower inner drip tip joint

Cat. No.	Effective Length, mm	Socket Size	Cone Size	Pack Size
16.140.0005	160	19/26	19/26	1
16.140.0010	200	19/26 or 24/29	24/29	1
16.140.0015	250	19/26 or 24/29	24/29	1
16.140.0025	300	24/29	24/29	1



Condenser, Ether

- Highly efficient coil condenser suitable for condensing very volatile liquids. Inner coil with large surface area. Outer water jacket to avoid vapour creep around the coil. Coil and jacket are independent and can be fed from separate water supplies for maximum efficiency.

Cat. No.	Effective Length, mm	Socket Size	Cone Size	Pack Size
16.144.0005	160	19/26	24/29	1
16.144.0010	200	19/26	24/29	1
16.144.0015	250	19/26	24/29	1

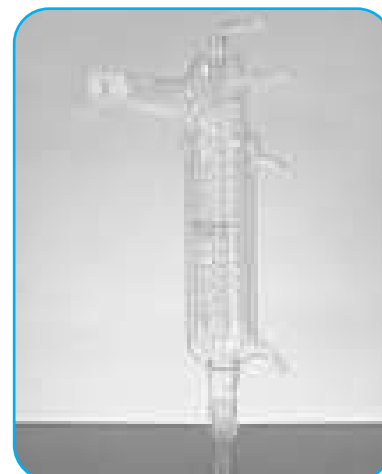

Condenser, Immersion (Cold Finger)

- For immersion into distillation assemblies etc.
- Can be used to regulate refluxing by adjusting the flow of air or water through it

Cat. No.	Effective Length, mm	Cone Size	Pack Size
16.148.0005	100	19/26	1



NOTE : All condensers can be supplied with different joint sizes as per requirement

Extractors

Soxhlet Extraction Apparatus, consist of Flask, Extractor and Condenser

Cat No.	Condenser type	Effective Capacity, ml	Extractor socket	Extractor cone	Flask Capacity, ml	Pack Size
16.308.0002	Allihin	60	34/35	24/29	150	1
16.308.0004	Allihin	100	40/38	24/29	250	1
16.308.0005	Allihin	100	45/40	29/32	250	1
16.308.0007	Allihin	200	50/42	24/29	500	1
16.308.0010	Allihin	250	45/40	29/32	500	1
16.308.0015	Allihin	500	60/46	29/32	1000	1
16.308.0020	Allihin	1000	71/55	29/32	2000	1
16.308.0025	Dimroth	100	45/40	29/32	250	1
16.308.0030	Dimroth	250	45/40	29/32	500	1
16.308.0035	Dimroth	500	60/46	29/32	1000	1
16.308.0040	Dimroth	1000	71/55	29/32	2000	1



Spare Extractor for Soxhlet Apparatus

- Conformity to DIN 12602
- Made of Borosilicate Glass
- Designed with a bulb in the siphon tube near the top, to aid the siphoning action
- The vapour tube also protects the siphon tube from accidental damage

Cat. No.	Effective Capacity, ml	Socket Size	Cone Size	Pack Size
16.312.0002	60	34/35	24/29	1
16.312.0004	100	40/38	24/29	1
16.312.0005	100	45/40	29/32	1
16.312.0007	200	50/42	24/29	1
16.312.0010	250	45/40	29/32	1
16.312.0015	500	60/46	29/32	1
16.312.0020	1000	71/55	29/32	1

Spare Condensers for Soxhlet Extraction Apparatus Allihn Condenser

- Made of Borosilicate Glass
- Greater Surface area than the Liebig Condenser owing to a series of bulbs, resulting in higher cooling capacity
- Ideal for laboratory scale refluxing

Cat. No.	Effective Capacity, ml	Cone Size	Effective Length, mm	Pack Size
16.301.0002	60	34/35	300	1
16.301.0004	100	40/38	300	1
16.301.0005	100	45/40	300	1
16.301.0007	200	50/42	400	1
16.301.0010	250	45/40	400	1
16.301.0015	500	60/46	400	1
16.301.0020	1000	71/55	400	1



Columns

Fractionating Column, Vigreux

Cat. No.	Effective Length, mm	Socket Size	Cone Size	Pack Size
16.201.0005	360	24/29	24/29	1
16.201.0010	600	24/29	24/29	1
16.201.0015	360	29/32	29/32	1
16.201.0020	750	34/35	34/35	1

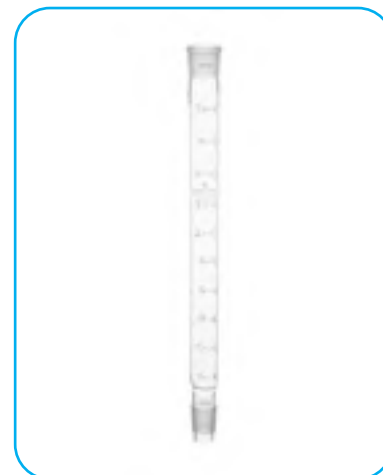

Fractionating Column, Dufton

Cat. No.	Effective Length, mm	Socket Size	Cone Size	Pack Size
16.204.0005	160	19/26	19/26	1
16.204.0010	300	19/26	19/26	1
16.204.0012	160	24/29	19/26	1
16.204.0014	300	24/29	19/26	1
16.204.0015	160	24/29	24/29	1
16.204.0020	300	24/29	24/29	1



Fractionating Column, Plain, Designed For Use With Various Types Of Column Packing

Cat. No.	Effective Length, mm	Socket Size	Cone Size	Pack Size
16.208.0005	250	24/29	24/29	1
16.208.0010	500	24/29	24/29	1
16.208.0015	500	29/32	29/32	1
16.208.0020	750	24/29	24/29	1
16.208.0025	250	34/35	24/29	1
16.208.0030	500	34/35	24/29	1
16.208.0035	600	34/35	34/35	1

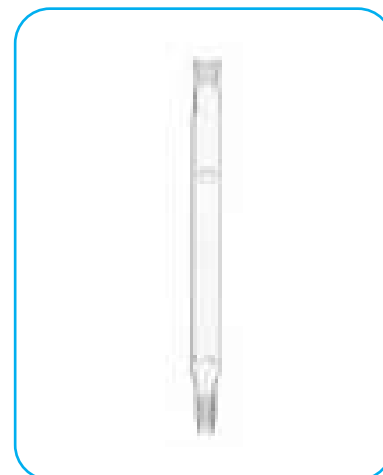

Plain Chromatography Absorption Columns

Cat. No.	Effective Length, cm	Dia. mm	Pack Size	Stopcock Type
18.152.0005	20	10	1	Without Stopcock
18.152.0010	30	15	1	Without Stopcock
18.152.0015	50	20	1	Without Stopcock
18.152.0020	60	25	1	Without Stopcock
18.152.0025	60	40	1	Without Stopcock
18.152.0030	100	50	1	Without Stopcock
18.156.0005	20	10	1	Glass Stopcock
18.156.0010	30	15	1	Glass Stopcock
18.156.0015	50	20	1	Glass Stopcock
18.156.0020	60	25	1	Glass Stopcock
18.156.0025	60	40	1	Glass Stopcock
18.156.0030	100	50	1	Glass Stopcock
18.180.0005	20	10	1	PTFE Needle Valve Stopcock
18.180.0010	30	15	1	PTFE Needle Valve Stopcock
18.180.0015	50	20	1	PTFE Needle Valve Stopcock
18.180.0020	60	25	1	PTFE Needle Valve Stopcock
18.180.0025	60	40	1	PTFE Needle Valve Stopcock
18.180.0030	100	50	1	PTFE Needle Valve Stopcock

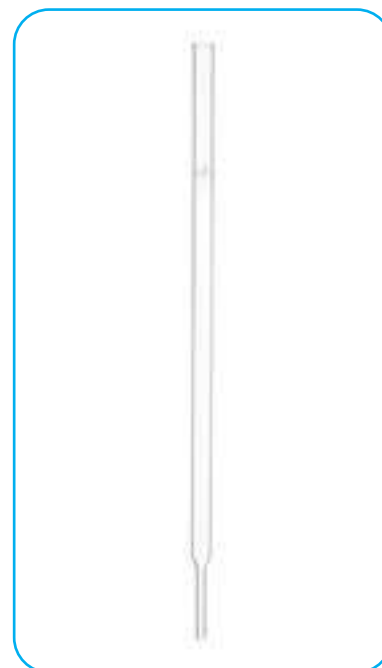
Chromatography Column, With Integral Sintered Disc(grade-1)

Cat. No.	Effective Length, cm	Disc dia. mm	Pack Size	Stopcock Type
18.164.0005	15	10	1	Without Stopcock
18.164.0010	20	15	1	Without Stopcock
18.164.0015	30	20	1	Without Stopcock
18.164.0020	40	20	1	Without Stopcock
18.164.0025	40	30	1	Without Stopcock
18.164.0030	50	30	1	Without Stopcock
18.164.0035	50	40	1	Without Stopcock
18.164.0040	60	40	1	Without Stopcock
18.164.0045	100	40	1	Without Stopcock
18.168.0005	15	10	1	Glass Stopcock
18.168.0010	20	15	1	Glass Stopcock
18.168.0015	30	20	1	Glass Stopcock
18.168.0020	40	20	1	Glass Stopcock
18.168.0025	40	30	1	Glass Stopcock
18.168.0030	50	30	1	Glass Stopcock
18.168.0035	50	40	1	Glass Stopcock
18.168.0040	60	40	1	Glass Stopcock
18.168.0045	100	40	1	Glass Stopcock
18.160.0005	15	10	1	PTFE Needle Valve Stopcock
18.160.0010	20	15	1	PTFE Needle Valve Stopcock
18.160.0015	30	20	1	PTFE Needle Valve Stopcock
18.160.0020	40	20	1	PTFE Needle Valve Stopcock
18.160.0025	40	30	1	PTFE Needle Valve Stopcock
18.160.0030	50	30	1	PTFE Needle Valve Stopcock
18.160.0035	50	40	1	PTFE Needle Valve Stopcock
18.160.0040	60	40	1	PTFE Needle Valve Stopcock
18.160.0045	100	40	1	PTFE Needle Valve Stopcock



Chromatography Column, With Integral Sintered Disc, Socket And Cone

Cat. No.	Bore mm	Effective Length, mm	Socket Size	Cone Size	Pack Size	Stopcock Type
18.184.0005	10	100	14/23	19/26	1	Glass Stopcock
18.184.0010	10	200	14/23	19/26	1	Glass Stopcock
18.184.0015	10	300	14/23	19/26	1	Glass Stopcock
18.184.0030	18	300	24/29	19/26	1	Glass Stopcock
18.184.0035	18	400	24/29	19/26	1	Glass Stopcock
18.184.0040	18	400	24/29	24/29	1	Glass Stopcock



Burners

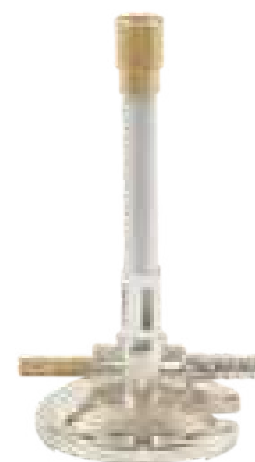

Burners
See Page No. 158-159

General Labware



**Vital Support to your Laboratory Procedures
Supertek General Purpose Glassware**

General Labware

supertek® brand Labware is manufactured from Low-expansion Boro 3.3 glass in conformance with ASTM E-438 TYPE 1 CLASS A glass & DIN ISO 3585. Our Labware has easy to read scale and large labeling field for easy marking in a durable white enamel. Uniform wall thickness makes these products ideal for heating applications. Printed in white as a standard.

Beaker, Low Form, With Graduation & Spout

- In compliance to ISO 3819/DIN 12331/IS 2619 Standard
- Printed in white color
- The spout design enables clean and precise pouring
- Uniform wall thickness distribution makes it ideal for heating liquids
- The easy-to-read scale and labeling field for marking
- High resistance to chemical attack

Cat. No	Capacity, ml	O.D. x Ht., mm	Pack Size
15.101.0005	5	22x30	12
15.101.0010*	10	25x35	12
15.101.0025	25	34x50	10
15.101.0050	50	42x60	10
15.101.0100	100	50x72	10
15.101.0150	150	60x80	10
15.101.0250	250	70x95	10
15.101.0400	400	80x110	10
15.101.0500	500	83x115	6
15.101.0600	600	90x125	6
15.101.1000	1000	105x146	6
15.101.2000	2000	130x185	4
15.101.3000	3000	150x210	1
15.101.5000	5000	170x270	1
15.101.9910	10000	220x350	1

*Supertek Specification



Amber Colour Beaker, Low Form, With Graduation & Spout

- In compliance to ISO 3819/DIN 12331/IS 2619 Standard
- Printed in white color
- The spout design enables clean and precise pouring
- Uniform wall thickness distribution makes it ideal for heating liquids
- The easy-to-read scale and labeling field for marking
- High resistance to chemical attack

Cat. No	Capacity, ml	O.D. x Ht., mm	Pack Size
15.102.0050	50	42x60	10
15.102.0100	100	50x72	10
15.102.0150	150	60x80	10
15.102.0250	250	70x95	10
15.102.0500	500	83x115	6



DIN
12331

ISO
3819

A
121 °C

Dish Washer
Durable
Print

Beaker, Tall Form, With Graduation & Spout

- In compliance to ISO 3819/DIN 12331 Standard, Printed in white color
- The spout design enables clean and precise pouring
- Uniform wall thickness distribution makes it ideal for heating liquids
- The easy-to-read scale and labeling field for marking
- High resistance to chemical attack

Cat. No.	Capacity, ml	O.D. x Ht., mm	Pack Size
15.104.0050	50	38x70	10
15.104.0100	100	48x80	10
15.104.0150	150	55x95	10
15.104.0250	250	60x120	10
15.104.0400	400	70x130	10
15.104.0500	500	80x138	6
15.104.0600	600	80x150	6
15.104.0800	800	90x175	6
15.104.1000	1000	90x200	6
15.104.2000	2000	120x240	4
15.104.3000	3000	135x280	4

*Supertek Specification



Beaker, Low Form, With Double Capacity Scale

- Conformity to ASTM E-960 Standard. Printed in white color
- The spout design enables clean and precise pouring
- Uniform wall thickness distribution makes it ideal for heating liquids
- The easy-to-read scale and labeling field for marking
- High resistance to chemical attack
- Double graduation metric scale for convenience

Cat No.	Capacity, ml	Graduation interval	O.D. x Ht., mm	Pack Size
15.105.0010*	10	-	25x35	12
15.105.0020*	20	10 ml	32x40	10
15.105.0030*	30	10 ml	36x55	10
15.105.0050	50	10 ml	42x60	10
15.105.0100	100	10 ml	50x72	10
15.105.0150	150	20 ml	60x80	10
15.105.0250	250	25 ml	70x95	10
15.105.0400	400	25 ml	80x110	10
15.105.0600	600	50 ml	90x125	6
15.105.1000	1000	50 ml	105x146	6
15.105.2000	2000	200 ml	130x185	4
15.105.4000*	4000	500 ml	160x250	1



DIN
12331

ISO
3819

A
121 °C

Dish Washer
Durable
Print

Beakers Philips, Conical With Spout

Cat. No	Capacity, ml	O.D. x Ht., mm	Pack Size
15.106.0250	250	68x110	2
15.106.0500	500	85x142	2



Laboratory Plasticware



Beaker Printed Graduation, PP
See Page No. 189

Flask, Flat Bottom

- In compliance to ISO 1773/IS:1381 Part 1 Standard, Printed in white color
- Uniform wall thickness distribution makes these Flasks ideal for heating
- Strong sturdy rim
- All sizes have a durable matt-finished enameled area for marking.

Cat No.	Capacity, ml	O.D. x Ht., mm	Pack Size
15.108.0005	5	30x55	10
15.108.0010	10	35x65	10
15.108.0025	25	42x75	10
15.108.0050	50	51x90	10
15.108.0100	100	64x105	10
15.108.0150	150	75x130	10
15.108.0250	250	85x138	10
15.108.0500	500	105x163	10
15.108.1000	1000	131x190	6
15.108.2000	2000	166x230	6
15.108.3000	3000	190x260	1
15.108.5000	5000	224x315	1
15.108.9910	10000	279x360	1
15.108.9920	20000	350x495	1



Amber Color Flasks, Boiling, Flat Bottom

Cat. No.	Capacity, ml	O.D. x Ht, mm	Pack Size
15.110.0050	50	51x90	10
15.110.0100	100	64x105	10
15.110.0250	250	85x138	10
15.110.0500	500	105x163	10
15.110.1000	1000	131x190	6
15.110.2000	2000	166x230	6



Flask Flat Bottom, Wide Neck

- Conformity to ISO 24450 Standard. Printed in white color
- Uniform wall thickness distribution makes these Flasks ideal for heating
- Strong sturdy rim
- All sizes have a durable matt-finished enameled area for marking

Cat No.	Capacity, ml	O.D. x Ht, mm	Pack Size
15.112.0050	50	51x90	10
15.112.0100	100	64x105	10
15.112.0250	250	85x138	10
15.112.0500	500	105x163	10
15.112.1000	1000	131x190	6



Flask, Round Bottom

- In Compliance to ISO 1773/IS:1381 Part 1 Standard, Printed in white color
- Uniform wall thickness distribution makes these Flasks ideal for heating
- Strong sturdy rim
- All sizes have a durable matt-finished enameled area for marking.

Cat No.	Capacity, ml	O.D. x Ht., mm	Pack Size
15.116.0005	5	30x60	10
15.116.0010	10	35x70	10
15.116.0025	25	42x90	10
15.116.0050	50	51x95	10
15.116.0100	100	64x110	10
15.116.0150	150	75x137	10
15.116.0250	250	85x143	10
15.116.0500	500	105x168	10
15.116.1000	1000	131x200	6
15.116.2000	2000	166x240	6
15.116.3000	3000	190x305	1
15.116.5000	5000	223x350	1
15.116.9910	10000	279x380	1
15.116.9920	20000	350x515	1

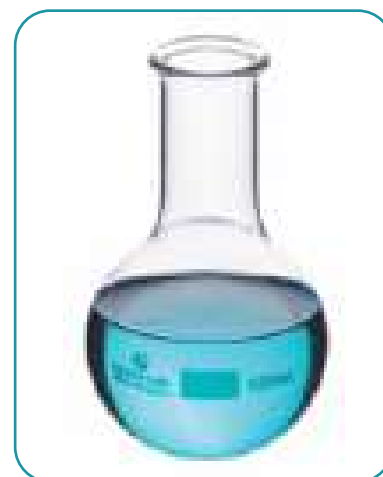

Amber Color Flasks, Boiling, Round Bottom

Cat. No.	Capacity, ml	O.D. x Ht., mm	Pack Size
15.118.0050	50	51x95	10
15.118.0100	100	64x110	10
15.118.0250	250	85x143	10
15.118.0500	500	105x168	10
15.118.1000	1000	131x200	6
15.118.2000	2000	166x240	6



Flask Support Polypropylene
See Page No. 193

ISO
1773

Dish Washer
Durable
Print

A
121 °C

Flask, Round Bottom, Wide Neck

- Conformity to ISO 24450 Standard. Printed in white color
- Uniform wall thickness distribution makes these Flasks ideal for heating
- Strong sturdy rim
- All sizes have a durable matt-finished enameled area for marking

Cat. No.	Capacity, ml	O.D. Ht., mm	Pack Size
15.120.0050	50	51x95	10
15.120.0100	100	64x110	10
15.120.0250	250	85x143	10
15.120.0500	500	105x168	10
15.120.1000	1000	131x200	6



Flask, Conical (Erlenmeyer) Graduated

- In Compliance to ISO 1773/IS:1381 Part 1 Standard.
- Uniform wall thickness distribution makes these Flasks ideal for heating
- Strong sturdy rim
- All sizes have an easy to read scale & durable matt-finished enameled area for marking
- The conical form makes them suitable for mixing liquids

Cat. No.	Capacity, ml	O.D. Ht., mm	Pack Size
15.124.0005	5	30x50	10
15.124.0010	10	30x60	10
15.124.0025	25	42x75	10
15.124.0050	50	51x90	10
15.124.0100	100	64x105	10
15.124.0150	150	72x124	10
15.124.0250	250	85x145	10
15.124.0500	500	105x180	10
15.124.1000	1000	131x220	6
15.124.2000	2000	166x280	6
15.124.3000	3000	187x310	1
15.124.4000	4000	198x356	1
15.124.5000	5000	220x365	1

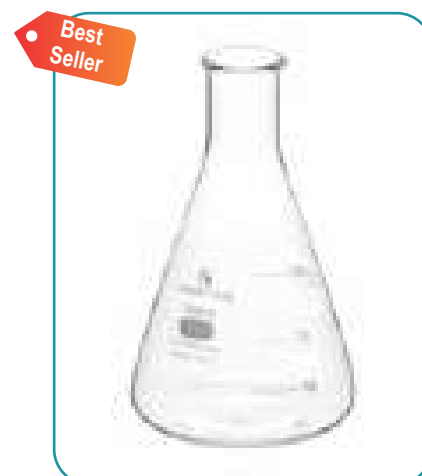

Amber Color Flask, Conical (Erlenmeyer) Graduated

Cat. No.	Capacity, ml	O.D. Ht., mm	Pack Size
15.126.0050	50	51x90	10
15.126.0100	100	64x105	10
15.126.0250	250	85x145	10
15.126.0500	500	105x180	10
15.126.1000	1000	131x220	6
15.126.2000	2000	166x280	6



Flask, Conical (Erlenmeyer) Graduated, Wide Neck

- In Compliance to IS/ISO 24450. Printed in white color
- Uniform wall thickness distribution makes these Flasks ideal for heating
- Strong sturdy rim
- All sizes have a durable matt-finished enameled area for marking

Cat. No.	Capacity, ml	O.D. X H.T MM	Pack Size
15.128.0025	25	42x75	10
15.128.0050	50	51x85	10
15.128.0100	100	64x105	10
15.128.0250	250	85x140	10
15.128.0500	500	105x175	10
15.128.1000	1000	131x220	6



Flasks Erlenmeyer, Conical, Long Neck, Without Rim

Cat. No.	Capacity, ml	Neck O.D.	Height mm	Pack Size
15.129.250	250	78	154	6

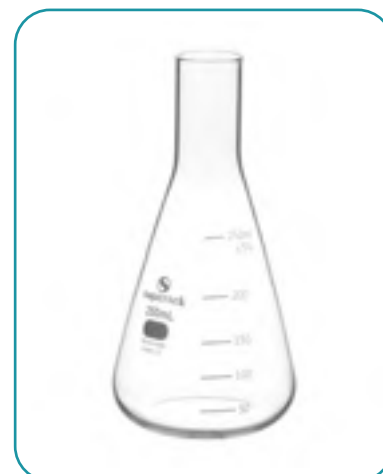

Flask, Kjeldahl, Long Neck

- Designed for Nitrogen Determination as per Kjeldahl Method

Cat. No.	Capacity, ml	Dia. mm	Approx. Height mm	Pack Size
15.132.0010	10	30	180	2
15.132.0030	30	40	180	2
15.132.0100	100	58	200	2
15.132.0300	300	81	295	2
15.132.0500	500	101	300	2
15.132.0500A*	500	101	325	2
15.132.0800	800	113	375	2
15.132.0800A*	800	118	340	2

* supertek standard

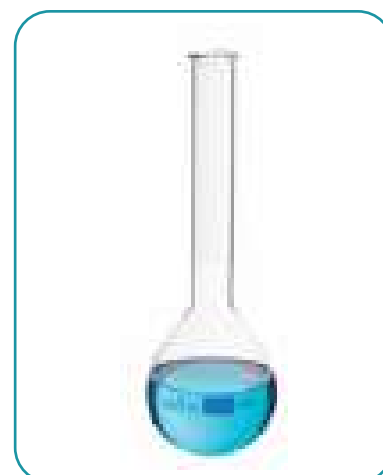

Flask, Kjeldahl, With Joint

Cat. No.	Capacity, ml	Socket Size	Approx Height mm	O.D. Ht., mm	Pack Size
15.136.0005	50	19/26	200	51x200	2
15.136.0010	100	19/26	200	60x200	2
15.136.0015	100	24/29	200	60x200	2
15.136.0020	300	24/29	295	85x295	2
15.136.0025	500	24/29	300	101x300	2
15.136.0025A*	500	24/29	325	101x325	2
15.136.0030	800	24/29	340	118x340	2
15.136.0030A*	800	24/29	375	113x375	2

* supertek standard

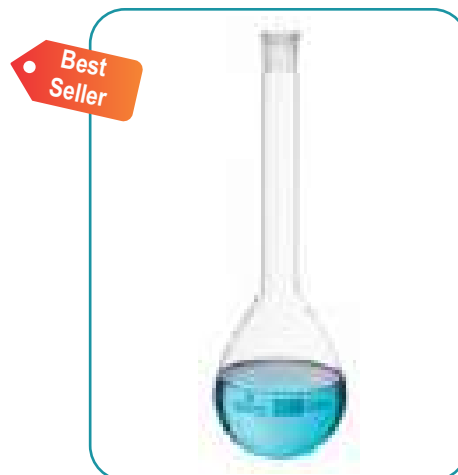

Schoinger Micro Combustion Flask, (Oxygen Flask) with Platinum wire gauge sample carrier, for determination of Halogens, Sulphur, Phosphorous metal etc.

Cat. No.	Capacity, ml	Pack Size
15.139.0500	500	1
15.139.1000	1000	1

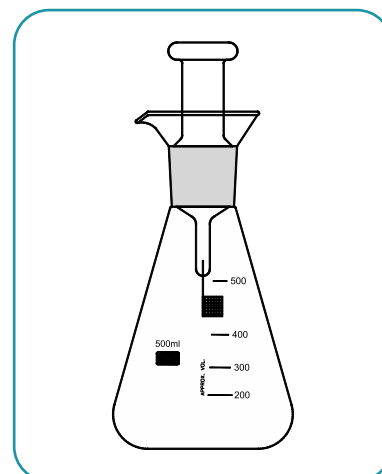

Filter Papers



Filter Papers See Page No. 145-146

Flask, Distillation, With Side Tube

- With side tube and reinforced bead
- In Compliance to ASTM 1405 Standard
- Uniform wall thickness distribution makes these Flasks ideal for heating
- All sizes have a durable matt-finished enameled area for marking
- Suitable for distillation process

Cat. No.	Capacity, ml	Pack Size
15.140.0025	25	2
15.140.0050	50	2
15.140.0100	100	2
15.140.0125	125	2
15.140.0250	250	2
15.140.0500	500	1
15.140.1000	1000	1



ASTM
1405

Flask, Distillation

- with 19/26 joint, side arm

Cat. No.	Capacity, ml	Ht. x OD (mm) Approx	Pack Size
15.144.0125	125	70x215	2



Flask, Filter Bolt Neck With Tubule At Side

- Heavy wall for Superior strength
- The shape is designed to impart maximum mechanical strength
- The neck finish is designed for strength and to ensure good stopper fit

Cat. No.	Capacity, ml	O.D. Ht., mm	Pack Size
15.152.0050	50	50x90	10
15.152.0100	100	70x110	10
15.152.0250	250	85x155	10
15.152.0500	500	105x185	10
15.152.1000	1000	135x230	6
15.152.2000	2000	165x290	6
15.152.5000	5000	240x445	1
15.152.9910	10000*	237x420	1
15.152.9920	20000*	287x535	1

* supertek standard



Superior
Strength

Flask Round Bottom, Single Neck

- Made of 3.3 borosilicate glass
- In Compliance to DIN ISO 4797 Standard. Printed in white color
- Uniform wall thickness distribution and the round-bottom shape makes them ideal for heating
- Equipped with standard interchangeable joint
- Large labelling field



Cat. No.	Capacity, ml	Socket Size	Pack Size
15.201.0001	5	10/19	10
15.201.0002	5	14/23	10
15.201.0003	10	10/19	10
15.201.0004	10	14/23	10
15.201.0005	25	14/23	10
15.201.0010 *	25	19/26	10
15.201.0015 *	25	24/29	10
15.201.0020	50	14/23	10
15.201.0025	50	19/26	10
15.201.0030	50	24/29	10
15.201.0035	50	29/32	10
15.201.0036	50	34/35	10
15.201.0040	100	14/23	10
15.201.0045	100	19/26	10
15.201.0050	100	24/29	10
15.201.0055	100	29/32	10
15.201.0056	100	34/35	10
15.201.0057	150	19/26	10
15.201.0058	150	24/29	10
15.201.0059	150	29/32	10
15.201.0059A	150	34/35	10
15.201.0060 *	250	14/23	10
15.201.0065	250	19/26	10
15.201.0070	250	24/29	10
15.201.0075	250	29/32	10
15.201.0080	250	34/35	10
15.201.0085	500	19/26	10
15.201.0090	500	24/29	10
15.201.0095	500	29/32	10
15.201.0100	500	34/35	10
15.201.0105 *	1000	19/26	6
15.201.0110	1000	24/29	6
15.201.0115	1000	29/32	6
15.201.0120 *	1000	34/35	6
15.201.0125	2000	24/29	6
15.201.0130	2000	29/32	6
15.201.0135 *	2000	34/35	6
15.201.0138	3000	24/29	1
15.201.0140 *	3000	29/32	1
15.201.0145 *	3000	34/35	1
15.201.0147	3000	40/38	1
15.201.0148	5000	24/29	1
15.201.0150	5000	29/32	1
15.201.0155	5000	34/35	1
15.201.0157	5000	40/38	1
15.201.0160	5000	45/40	1
15.201.0162	5000	50/42	1
15.201.0163	5000	55/44	1
15.201.0165	10000	34/35	1
15.201.0168	10000	40/38	1
15.201.0170	10000	45/40	1
15.201.0185	10000	50/42	1
15.201.0190	10000	55/44	1
15.201.0195	20000	40/38	1
15.201.0200	20000	50/42	1
15.201.0205	20000	55/44	1

* Non ISO sizes

Amber Colour Flasks, Round Bottom, Single Neck

Cat. No.	Capacity, ml	Socket Size	Pack Size
15.203.0025	25	14/23	10
15.203.0050	50	24/29	10
15.203.0100	100	24/29	10
15.203.0150	150	24/29	10
15.203.0250	250	24/29	10
15.203.0500	500	24/29	10
15.203.1000	1000	24/29	6
15.203.2000	2000	29/32	6



Flask Flat Bottom, Single Neck

- In Compliance to DIN ISO 4797 Standard. Printed in white color
- Uniform wall thickness distribution makes these flasks ideal for heating
- All sizes have a durable matt-finished enameled area for marking with an ordinary pencil
- Equipped with standard interchangeable joint
- The flat base ensures that the flask can be placed down even without the supporting ring

Cat. No.	Capacity, ml	Socket Size	Pack Size
15.204.0001A	5	10/19	10
15.204.0001B	5	14/23	10
15.204.0002A	10	10/19	10
15.204.0002B	10	14/23	10
15.204.0003A	25	14/23	10
15.204.0003B	25	19/26	10
15.204.0003C	25	24/29	10
15.204.0004	50	14/23	10
15.204.0005	50	19/26	10
15.204.0010	50	24/29	10
15.204.0015	50	29/32	10
15.204.0016	50	34/35	10
15.204.0018	100	14/23	10
15.204.0020	100	19/26	10
15.204.0025	100	24/29	10
15.204.0030	100	29/32	10
15.204.0032	100	34/35	10
15.204.0035 *	150	19/26	10
15.204.0040 *	150	24/29	10
15.204.0045 *	150	29/32	10
15.204.0048	150	34/35	10
15.204.0050	250	19/26	10
15.204.0055	250	24/29	10
15.204.0060	250	29/32	10
15.204.0065	250	34/35	10
15.204.0067	300	24/29	10
15.204.0070 *	500	19/26	10
15.204.0075	500	24/29	10
15.204.0080	500	29/32	10
15.204.0085	500	34/35	10
15.204.0090	1000	24/29	6
15.204.0095	1000	29/32	6
15.204.0100	1000	34/35	6
15.204.0105	2000	24/29	6
15.204.0110	2000	29/32	6
15.204.0115	2000	34/35	6
15.204.0120	3000	24/29	1
15.204.0125	3000	34/35	1
15.204.0130	3000	40/38	1
15.204.0135	5000	24/29	1
15.204.0140	5000	34/35	1
15.204.0145	5000	40/38	1
15.204.0150	5000	45/40	1
15.204.0155	5000	50/42	1
15.204.0160	10000	34/35	1
15.204.0165	10000	40/38	1
15.204.0170	10000	45/40	1
15.204.0175	10000	50/42	1
15.204.0180	10000	55/44	1
15.204.0185	20000	40/38	1
15.204.0190	20000	50/42	1
15.204.0195	20000	55/44	1

* Non ISO sizes



Amber Colour Flasks, Flat Bottom, Single Neck

Cat. No.	Capacity, ml	Socket Size	Pack Size
15.205.0025	25	14/23	10
15.205.0050	50	24/29	10
15.205.0100	100	24/29	10
15.205.0150	150	24/29	10
15.205.0250	250	24/29	10
15.205.0500	500	24/29	10
15.205.1000	1000	24/29	6
15.205.2000	2000	29/32	6

Dish Washer
Durable
Print

A
121 °C

Flask Round Bottom, Two Necks (Side neck at Angle)

- In Compliance to DIN 12394 Standard. Printed in white color
- Uniform wall thickness distribution and the round-bottom shape makes them ideal for heating
- Accessories, thermometer, column, dropping funnels, boiling capillaries, etc., can be fitted depending upon the application
- Generally used in distillation and extraction processes

Cat. No.	Capacity, ml	Socket Center Neck	Socket Side Neck	Pack Size
15.208.0002	25	19/26	14/23	2
15.208.0003	25	24/29	19/26	2
15.208.0004	50	19/26	14/23	2
15.208.0005	50	24/29	14/23	2
15.208.0010	50	29/32	14/23	2
15.208.0015	100	24/29	14/23	2
15.208.0020	100	24/29	19/26	2
15.208.0025	100	29/32	14/23	2
15.208.0030	250	24/29	14/23	1
15.208.0035	250	24/29	19/26	1
15.208.0040	250	29/32	14/23	1
15.208.0045	500	24/29	14/23	1
15.208.0050	500	24/29	19/26	1
15.208.0055	500	29/32	14/23	1
15.208.0060	1000	24/29	14/23	1
15.208.0065	1000	24/29	19/26	1
15.208.0070	1000	29/32	14/23	1
15.208.0071	1000	34/35	14/23	1
15.208.0072	1000	34/35	19/26	1
15.208.0073	2000	24/29	19/26	1
15.208.0074	2000	24/29	24/29	1
15.208.0075	2000	34/35	19/26	1
15.208.0080	2000	34/35	24/29	1
15.208.0085	3000	24/29	14/23	1
15.208.0090	3000	24/29	19/26	1
15.208.0095	3000	24/29	24/29	1
15.208.0100	3000	34/35	14/23	1
15.208.0105	3000	34/35	19/26	1
15.208.0110	3000	34/35	24/29	1
15.208.0115	5000	24/29	14/23	1
15.208.0120	5000	24/29	19/26	1
15.208.0125	5000	24/29	24/29	1
15.208.0130	5000	34/35	14/23	1
15.208.0135	5000	34/35	19/26	1
15.208.0140	5000	34/35	24/29	1
15.208.0145	5000	40/38	14/23	1
15.208.0150	5000	40/38	19/26	1
15.208.0155	5000	40/38	24/29	1
15.208.0160	10000	50/42	19/23	1
15.208.0165	10000	50/42	24/29	1
15.208.0170	10000	50/42	34/35	1
15.208.0175	10000	55/44	19/26	1
15.208.0180	10000	55/44	24/29	1
15.208.0185	10000	55/44	34/35	1
15.208.0190	20000	50/42	19/26	1
15.208.0195	20000	50/42	24/29	1
15.208.0200	20000	50/42	34/35	1
15.208.0205	20000	55/44	19/26	1
15.208.0210	20000	55/44	24/29	1
15.208.0215	20000	55/44	34/35	1



Flask Round Bottom, Two Necks (Side Neck Parallel)

Cat. No.	Capacity, ml	Socket center neck	Socket Side Neck	Pack Size
15.210.0020	50	24/29	14/23	2
15.210.0025	50	29/32	14/23	2
15.210.0030	100	24/29	14/23	2
15.210.0035	100	24/29	19/26	2
15.210.0040	100	29/32	14/23	2
15.210.0045	250	24/29	14/23	1
15.210.0050	250	24/29	19/26	1
15.210.0055	250	29/32	14/23	1
15.210.0060	500	24/29	14/23	1
15.210.0065	500	24/29	19/26	1
15.210.0070	500	29/32	14/23	1
15.210.0075	1000	24/29	14/23	1
15.210.0080	1000	24/29	19/26	1
15.210.0085	1000	29/32	14/23	1
15.210.0090	1000	34/35	14/23	1
15.210.0095	1000	34/35	19/26	1
15.210.0100	2000	24/29	19/26	1
15.210.0105	2000	24/29	24/29	1
15.210.0110	2000	34/35	19/26	1
15.210.0115	2000	34/35	24/29	1
15.210.0120	3000	24/29	14/23	1
15.210.0125	3000	24/29	19/26	1
15.210.0130	3000	24/29	24/29	1
15.210.0135	3000	34/35	14/23	1
15.210.0140	3000	34/35	19/26	1
15.210.0145	3000	34/35	24/29	1
15.210.0150	5000	24/29	14/23	1
15.210.0155	5000	24/29	19/26	1
15.210.0160	5000	24/29	24/29	1
15.210.0165	5000	34/35	14/23	1
15.210.0170	5000	34/35	19/26	1
15.210.0175	5000	34/35	24/29	1
15.210.0180	5000	40/38	14/23	1
15.210.0185	5000	40/38	19/26	1
15.210.0190	5000	40/38	24/29	1
15.210.0195	10000	50/42	19/26	1
15.210.0200	10000	50/42	24/29	1
15.210.0205	10000	50/42	34/35	1
15.210.0210	10000	55/44	19/26	1
15.210.0215	10000	55/44	24/29	1
15.210.0220	10000	55/44	34/35	1
15.210.0225	20000	50/42	19/26	1
15.210.0230	20000	50/42	24/29	1
15.210.0235	20000	50/42	34/35	1
15.210.0240	20000	55/44	19/26	1
15.210.0245	20000	55/44	24/29	1
15.210.0250	20000	55/44	34/35	1



Dish Washer
Durable
Print

A
121 °C

Flask Round Bottom, Three Necks At Angle

- Printed in white color
- Uniform wall thickness and the round-bottom shape makes them ideal for heating
- Accessories, thermometer, column, dropping funnels, boiling capillaries, etc., can be fitted depending upon the application
- Generally used in distillation and extraction processes

Cat. No.	Capacity, ml	Center Socket	Side Sockets	Pack Size
15.212.0002	50	19/26	14/23	2
15.212.0003	50	24/29	19/26	2
15.212.0005	100	19/26	14/23	2
15.212.0010	100	24/29	14/23	2
15.212.0015	100	24/29	19/26	2
15.212.0020	100	29/32	14/23	2
15.212.0025	250	19/26	19/26	1
15.212.0030	250	24/29	14/23	1
15.212.0035	250	24/29	19/26	1
15.212.0040	250	29/32	14/23	1
15.212.0045	250	29/32	19/26	1
15.212.0050	250	29/32	29/32	1
15.212.0055	500	24/29	14/23	1
15.212.0060	500	24/29	19/26	1
15.212.0065	500	29/32	14/23	1
15.212.0070	500	29/32	19/26	1
15.212.0075	500	29/32	29/32	1
15.212.0080	1000	24/29	14/23	1
15.212.0085	1000	24/29	19/26	1
15.212.0090	1000	29/32	14/23	1
15.212.0095	1000	29/32	19/26	1
15.212.0100	1000	29/32	29/32	1
15.212.0102	1000	34/35	19/26	1
15.212.0105	2000	24/29	19/26	1
15.212.0110	2000	29/32	24/29	1
15.212.0115	2000	29/32	29/32	1
15.212.0125	2000	34/35	19/26	1
15.212.0130	2000	34/35	24/29	1
15.212.0135	3000	34/35	19/26	1
15.212.0140	3000	34/35	24/29	1
15.212.0145	5000	34/35	19/26	1
15.212.0150	5000	40/38	19/26	1
15.212.0155	5000	50/42	19/26	1
15.212.0160	5000	55/44	19/26	1
15.212.0165	5000	34/35	24/29	1
15.212.0170	5000	40/38	24/29	1
15.212.0175	5000	50/42	24/29	1
15.212.0180	5000	55/44	24/29	1
15.212.0185	10000	34/35	19/26	1
15.212.0190	10000	40/38	19/26	1
15.212.0195	10000	50/42	19/26	1
15.212.0200	10000	55/44	19/26	1
15.212.0205	10000	34/35	24/29	1
15.212.0210	10000	50/42	24/29	1
15.212.0215	10000	55/44	24/29	1
15.212.0220	20000	34/35	19/26	1
15.212.0225	20000	50/42	19/26	1
15.212.0230	20000	55/44	19/26	1
15.212.0240	20000	34/35	24/29	1
15.212.0245	20000	50/42	24/29	1
15.212.0250	20000	55/44	24/29	1



Flask Round Bottom, Three Necks Parallel

- In Compliance to DIN 12392 Standard. Printed in white color
- Uniform wall thickness distribution and the round-bottom shape makes them ideal for heating
- Accessories, thermometer, column, dropping funnels, boiling capillaries, etc., can be fitted depending upon the application
- Generally used in distillation and extraction processes

Cat.No.	Capacity, ml	Center Sockets	Side Sockets	Pack Size
15.216.0003	100	24/29	14/23	2
15.216.0004	250	24/29	14/23	1
15.216.0005	250	24/29	19/26	1
15.216.0010	250	29/32	14/23	1
15.216.0015	250	29/32	29/32	1
15.216.0017	500	24/29	14/23	1
15.216.0020	500	24/29	19/26	1
15.216.0025	500	29/32	14/23	1
15.216.0030	500	29/32	19/26	1
15.216.0035	500	29/32	29/32	1
15.216.0037	1000	24/29	14/23	1
15.216.0040	1000	24/29	19/26	1
15.216.0045	1000	29/32	14/23	1
15.216.0050	1000	29/32	19/26	1
15.216.0055	1000	29/32	24/29	1
15.216.0060	1000	29/32	29/32	1
15.216.0062	1000	34/35	19/26	1
15.216.0065	2000	24/29	19/26	1
15.216.0070	2000	29/32	19/26	1
15.216.0075	2000	29/32	29/32	1
15.216.0080	2000	34/35	19/26	1
15.216.0085	2000	34/35	24/29	1
15.216.0090	2000	45/40	29/32	1
15.216.0095	3000	34/35	19/26	1
15.216.0100	3000	34/35	24/29	1
15.216.0105	5000	34/35	19/26	1
15.216.0110	5000	34/35	24/29	1
15.216.0115	5000	40/38	19/26	1
15.216.0120	5000	40/38	24/29	1
15.216.0125	5000	50/42	19/26	1
15.216.0130	5000	50/42	24/29	1
15.216.0135	5000	55/44	19/26	1
15.216.0140	5000	55/44	24/29	1
15.216.0145	10000	34/35	19/26	1
15.216.0150	10000	40/38	19/26	1
15.216.0155	10000	50/42	19/26	1
15.216.0160	10000	55/44	19/26	1
15.216.0165	10000	34/35	24/29	1
15.216.0170	10000	50/42	24/29	1
15.216.0175	10000	55/44	24/29	1
15.216.0180	20000	34/35	19/26	1
15.216.0185	20000	50/42	19/26	1
15.216.0190	20000	55/44	19/26	1
15.216.0200	20000	34/35	24/29	1
15.216.0205	20000	50/42	24/29	1
15.216.0210	20000	55/44	24/29	1



Dish Washer
Durable
Print

A
121 °C

Heating Mantles
With Stirrer
See Page No. 176

Round Bottom Flask, Four Necks (Parallel)

Cat. No.	Capacity, ml	Center Socket	Side Sockets	Pack Size
15.217.0005	50	24/29	24/29	1
15.217.0010	100	24/29	14/23	1
15.217.0015	100	24/29	19/26	1
15.217.0020	250	19/26	19/26	1
15.217.0025	250	24/29	14/23	1
15.217.0030	250	24/29	19/26	1
15.217.0035	250	29/32	14/23	1
15.217.0040	250	29/32	29/32	1
15.217.0045	500	19/26	19/26	1
15.217.0050	500	24/29	14/23	1
15.217.0055	500	24/29	19/26	1
15.217.0065	500	24/29	24/29	1
15.217.0070	500	29/32	14/23	1
15.217.0075	500	29/32	19/26	1
15.217.0080	500	29/32	29/32	1
15.217.0085	500	34/35	24/29	1
15.217.0090	1000	24/29	14/23	1
15.217.0095	1000	24/29	19/26	1
15.217.0100	1000	24/29	24/29	1
15.217.0105	1000	29/32	14/23	1
15.217.0110	1000	29/32	19/26	1
15.217.0115	1000	29/32	24/29	1
15.217.0120	1000	29/32	29/32	1
15.217.0125	1000	34/35	24/29	1
15.217.0130	2000	24/29	14/23	1
15.217.0135	2000	24/29	19/26	1
15.217.0140	2000	29/32	19/26	1
15.217.0145	2000	29/32	29/32	1
15.217.0150	2000	34/35	19/26	1
15.217.0155	2000	34/35	24/29	1
15.217.0160	3000	34/35	19/26	1
15.217.0165	3000	34/35	24/29	1
15.217.0170	5000	34/35	19/26	1
15.217.0175	5000	34/35	24/29	1
15.217.0180	10000	34/35	24/29	1
15.217.0185	10000	45/40	24/29	1
15.217.0190	10000	55/44	24/29	1
15.217.0195	20000	55/44	24/29	1



**Heating Mantles
Multi-Position
See Page No. 178**

Dish Washer
Durable
Print

A
121 °C

Round Bottom Flask, Four Necks (At An Angle)

Cat. No.	Capacity, ml	Center Socket	Side Sockets	Pack Size
15.218.0005	50	24/29	24/29	1
15.218.0010	100	14/23	14/23	1
15.218.0015	100	19/26	14/23	1
15.218.0020	100	24/29	14/23	1
15.218.0025	100	24/29	19/26	1
15.218.0030	100	29/32	14/23	1
15.218.0035	250	19/26	14/23	1
15.218.0040	250	19/26	19/26	1
15.218.0045	250	24/29	14/23	1
15.218.0050	250	24/29	19/26	1
15.218.0055	250	29/32	14/23	1
15.218.0060	250	29/32	19/26	1
15.218.0065	250	29/32	29/32	1
15.218.0070	500	24/29	14/23	1
15.218.0080	500	24/29	19/26	1
15.218.0085	500	24/29	24/29	1
15.218.0090	500	29/32	14/23	1
15.218.0095	500	29/32	19/26	1
15.218.0100	500	29/32	29/32	1
15.218.0105	500	34/35	24/29	1
15.218.0110	1000	24/29	14/23	1
15.218.0115	1000	24/29	19/26	1
15.218.0120	1000	24/29	24/29	1
15.218.0125	1000	29/32	14/23	1
15.218.0130	1000	29/32	19/26	1
15.218.0135	1000	29/32	29/32	1
15.218.0140	1000	34/35	24/29	1
15.218.0145	2000	24/29	14/23	1
15.218.0150	2000	24/29	19/26	1
15.218.0155	2000	29/32	24/29	1
15.218.0160	2000	29/32	29/32	1
15.218.0165	2000	34/35	19/26	1
15.218.0170	2000	34/35	24/29	1
15.218.0175	3000	34/35	19/26	1
15.218.0180	3000	34/35	24/29	1
15.218.0185	5000	34/35	19/26	1
15.218.0190	5000	34/35	24/29	1
15.218.0195	10000	34/35	24/29	1
15.218.0200	10000	45/40	24/29	1
15.218.0205	10000	55/44	24/29	1
15.218.0210	20000	55/44	24/29	1

Flasks, Solvent Storage, Glass stopcock

Cat. No.	Capacity, ml	Socket Size	Pack Size
15.219.0025	25	14/23	1
15.219.0050	50	14/23	1
15.219.0100	100	19/26	1
15.219.0250	250	24/29	1
15.219.0500	500	24/29	1

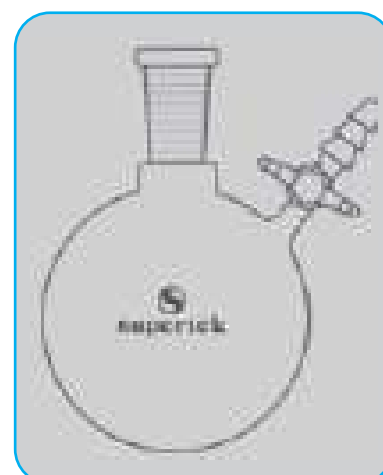

Flask Pear Shape, Single Neck

- Made of 3.3 borosilicate glass
- The conical shape makes them ideal for small scale reaction
- Large labelling field

Cat. No.	Capacity, ml	Socket Size	Approx Overall Height, mm	Approx Overall Diameter mm	Pack Size
15.220.0005A	5	10/19	67	23	25
15.220.0010A	10	10/19	75	28	25
15.220.0010B	10	14/23	75	28	25
15.220.0025A	25	10/19	90	38	10
15.220.0025	25	14/23	90	38	10
15.220.0050	50	14/23	110	48	10
15.220.0050B	50	19/26	110	48	10
15.220.0100	100	14/23	125	58	10
15.220.0100B	100	19/26	125	58	10
15.220.0100C	100	24/29	125	58	10



Flask Pear Shape, Two Necks

Cat. No.	Capacity, ml	Socket Center Necks	Socket Side Necks	Pack Size
15.224.0025	25	14/23	14/23	1
15.224.0050	50	14/23	14/23	1
15.224.0100	100	14/23	14/23	1



Flask, Evaporating, Florentine

- To be used in Rotary Evaporator. Printed in white color.
- Ideal for heating sensitive solvent solute combinations
- Facilitate the extraction of key components like odour, oil, drugs, natural extract and fragrance

Cat. No.	Capacity, ml	Socket Size	Approx Overall Height, mm	Pack Size
15.248.0050A	50	24/29	94	2
15.248.0050	50	29/32	94	2
15.248.0100A	100	24/29	110	2
15.248.0100	100	29/32	110	2
15.248.0250A	250	24/29	140	2
15.248.0250	250	29/32	140	2
15.248.0500A	500	24/29	170	2
15.248.0500	500	29/32	170	2
15.248.1000A	1000	24/29	210	2
15.248.1000	1000	29/32	210	2
15.248.2000	2000	29/32	235	2



Flask, Conical, (Erlenmeyer) With Joint

- Conformity to ISO 4797 Standard. Easy to read scale, printed in white color.
- Uniform wall thickness distribution makes these flasks ideal for heating
- The conical form makes them suitable for mixing of liquids
- Equipped with standard interchangeable joints

Cat. No.	Capacity, ml	Socket Size	O.D. Ht., mm	Pack Size
15.252.0003	25	10/19	42x70	10
15.252.0005	25	14/23	42x70	10
15.252.0010	25	19/26	42x70	10
15.252.0015	50	14/23	51x85	10
15.252.0020	50	19/26	51x85	10
15.252.0025	50	24/29	51x85	10
15.252.0030	50	29/32	51x85	10
15.252.0035	100	14/23	64x105	10
15.252.0040	100	19/26	64x105	10
15.252.0045	100	24/29	64x105	10
15.252.0050	100	29/32	64x105	10
15.252.0052	150	19/26	72x120	10
15.252.0053	150	24/29	72x120	10
15.252.0054	150	29/32	72x120	10
15.252.0055	200	29/32	80x143	10
15.252.0060	250	19/26	85x135	10
15.252.0065	250	24/29	85x135	10
15.252.0070	250	29/32	85x135	10
15.252.0072	250	34/35	85x135	10
15.252.0075	300	29/32	90x145	10
15.252.0080	500	19/26	105x170	10
15.252.0085	500	24/29	105x170	10
15.252.0090	500	29/32	105x170	10
15.252.0093	500	34/35	105x170	10
15.252.0095	1000	24/29	131x210	6
15.252.0100	1000	29/32	131x210	6
15.252.0105	1000	34/35	131x210	6
15.252.0108	2000	24/29	166x275	6
15.252.0110	2000	29/32	166x275	6
15.252.0120	2000	34/35	166x275	6

ISO
4797Dish Washer
Durable
PrintA
121 °C

Flask, Conical, (Erlenmeyer) With Screw Cap

- Easy to read scale, printed in white color.
- Uniform wall thickness distribution makes these flasks ideal for heating
- The conical form makes them suitable for mixing of liquids
- Caps made of PP can be used to close these flasks

Cat. No.	Capacity, ml	Pack Size	Cap Size
15.256.0025	25	10	GL-25
15.256.0050	50	10	GL-25
15.256.0100	100	10	GL-25
15.256.0150	150	10	GL-25
15.256.0250	250	10	GL-32
15.256.0250A	250	10	GL-45
15.256.0500	500	10	GL-32
15.256.0500A	500	10	GL-45
15.256.1000	1000	6	GL-32
15.256.1000A	1000	6	GL-45
15.256.2000	2000	6	GL-45
15.256.5000	5000	1	GL-45



Flasks Conical, With Interchangeable Stopper, Hollow

- Easy to read scale, printed in white color
- Uniform wall thickness distribution makes these flasks ideal for heating
- The conical form makes them suitable for mixing of liquids
- These Flasks can be closed with a glass stopper

Cat. No.	Capacity, ml	Socket Size	Pack Size
15.260.0025	25	14/23	10
15.260.0050	50	19/26	10
15.260.0100E	100	24/29	10
15.260.0100	100	29/32	10
15.260.0250E	250	24/29	10
15.260.0250	250	29/32	10
15.260.0500E	500	24/29	10
15.260.0500	500	29/32	10
15.260.1000E	1000	24/29	6
15.260.1000	1000	29/32	6
15.260.2000	2000	29/32	6



Amber Color Flask Conical With Interchangeable Stopper, Hollow

Cat. No.	Capacity, ml	Socket Size	Pack Size
15.262.0025	25	14/23	10
15.262.0050	50	19/26	10
15.262.0100	100	29/32	10
15.262.0250	250	29/32	10
15.262.0500	500	29/32	10
15.262.1000	1000	29/32	6
15.262.2000	2000	29/32	6



Flask, Iodine

- For determination of Iodine with ground joint and stopper
- Large labeling field for easy marking
- The handle of the stopper projects above the liquid seal, facilitating its removal

Cat. No.	Capacity, ml	Joint Size	Pack Size
15.264.0003	100	24/29	10
15.264.0005	250	24/29	10
15.264.0010	250	29/32	10
15.264.0015	500	24/29	10
15.264.0020	500	29/32	10
15.264.0025	1000	24/29	6



Flask Reaction, Wide Neck

- 100 mm i.d., 150 mm o.d, flat flange joint

Cat. No.	Capacity, ml	Pack Size
15.268.1000	1000	1
15.268.2000	2000	1
15.268.3000	3000	1
15.268.5000	5000	1
15.268.9910	10000	1
15.268.9920	20000	1



Flask, Culture, Haffkine

- In Compliance to IS 7183
- The large, flat bottom surface ensures uniform culture thickness
- Typically used for the preparation of culture in nutrient media

Cat. No.	Capacity, ml	Approx. O.D. Ht. (mm)	Pack Size
15.280.3000	3000*	245 x 280	2
15.280.4000	4000	246 x 310	2

* 3000 ml not covered in standards



Jars, Rectangular, Museum, With Cover Soda Lime Glass

- Not recommended for use over a direct flame or on a hot plate

Cat. No.	Approx. Height x Length x Breadth mm	Quantity Per Case
15.277.0005	140x215x100	1
15.277.0010	210x170x130	1
15.277.0015	220x140x140	1
15.277.0020	225x225x125	1
15.277.0025	250x250x150	1



Weighing Scoop

- Weighing Scoops have an open tubular arm
- Ideal for weighing small quantities of dyes, powder, liquid or semi-solid material

Cat. No.	Capacity, ml	Pack Size
15.315.0001	1	10
15.315.0002	2	10
15.315.0003	3	10
15.315.0006	6	10
15.315.0010	10	10



Watch Glass, Soda Lime Glass

Cat. No.	Diam., mm	Pack Size
CH13090/1A	35	20
CH13090/1	50	20
CH13090/2	65	20
CH13090/3	75	20
CH13090/4	80	20
CH13090/5	100	20
CH13090/7	120	20
CH13090/10	150	10



Flask For Dissolution Apparatus, Without Side Cut as per USP, with Certificate

- In compliance with requirements of USP Ch. 711
- Smooth base, straight sides and a flat flange
- Graduated in intervals of 50ml
- Used in determination of dissolution characteristics of drugs in capsules and tablets

Cat. No.	Capacity ml	Approx O.D. x Height mm	Pack Size
15.322.1000	1000	131 x 173	6
15.322.2000	2000	131 x 285	2

Flask For Dissolution Apparatus, With Side Cut as per USP, with Certificate

- In compliance to requirements of USP Ch. 711
- Smooth base, straight sides and a flat flange side-cuts at the flange
- Graduated in intervals of 50ml
- Used in determination of dissolution characteristics of drugs in capsules and tablets

Cat. No.	Capacity ml	Approx O.D. x Height mm	Pack Size
15.324.1000	1000	124 x 173	6
15.324.2000	2000	131 x 285	2

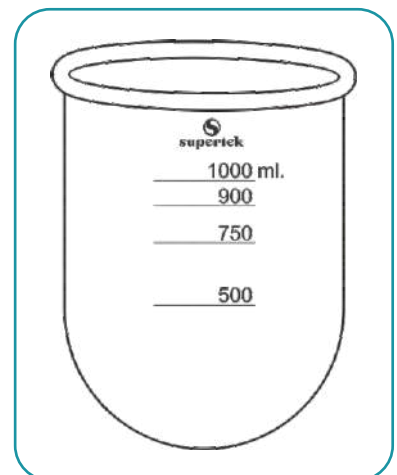

Amber Flask For Dissolution Apparatus, Without Side Cut as per USP, with Certificate

- In Compliance with requirements of USP Ch. 711
- Smooth base, straight sides and a flat flange
- Graduated in intervals of 50ml
- Used in determination of dissolution characteristics of drugs in capsules and tablets
- Amber color is applied to reduce UV light penetration

Cat. No.	Capacity ml	Approx O.D. x Height mm	Pack Size
15.326.1000	1000	131 x 173	6
15.326.2000	2000	131 x 285	2

Amber Flask For Dissolution Apparatus, With Side Cut as per USP, with Certificate

- In Compliance with requirements of USP Ch. 711
- Smooth base, straight sides and a flat flange side-cuts at the flange
- Graduated in intervals of 50ml
- Used in determination of dissolution characteristics of drugs in capsules and tablets
- Amber color is applied to reduce UV light penetration

Cat. No.	Capacity ml	Approx O.D. x Height mm	Pack Size
15.328.1000	1000	124 x 173	6
15.328.2000	2000	124 x 285	2



Funnels

Filter Funnel, Plain, Long Stem

- In Compliance to ISO / DIN 4798
- Made of thermal shock resistant and chemical resistant Borosilicate 3.3 glass
- Designed with a 60° angle to ensure precise fitting of the filter paper
- Generally used for filtering and decanting liquids of varied densities

Cat. No.	Length-Stem (Approx) mm	Diam., mm	Pack Size
15.301.0025	150	25	10
15.301.0038	150	38	10
15.301.0050	150	50	10
15.301.0065	150	65	10
15.301.0075	150	75	10
15.301.0100	150	100	6
15.301.0125	200	125	4
15.301.0150	200	150	4



Powder Funnel

- Ideal for transferring powders
- Designed with a short wide stem to facilitate smooth flow
- Made of thermal shock resistant and chemical resistant Borosilicate 3.3 glass
- Supplied with ground glass cone for easy fitting on flask

Cat. No.	Funnel diam. Approx., mm	Cone Size	Pack Size
15.308.0005	45	14/23	10
15.308.0010	70	14/23	10
15.308.0015	70	29/32	10
15.308.0020	80	29/32	10
15.308.0025	100	14/23	6
15.308.0028	100	24/29	6
15.308.0030	100	29/32	6
15.308.0035	125	24/29	4
15.308.0040	150	24/29	4
15.310.0055	55	-	10
15.310.0080	80	-	10
15.310.0100	100	-	6
15.310.0125	125	-	4
15.310.0150	150	-	4



Filter Funnel, Plain, Short Stem

- Complies with ISO / DIN 4798
- Made of thermal shock resistant and chemical resistant Borosilicate 3.3 glass
- Designed with a 60° bowl angle to ensure precise fitting of the filter paper
- Generally used for filtering and decanting liquids of varied densities

Cat. No.	Diam., mm	Pack Size
15.304.0025	25	10
15.304.0038	38	10
15.304.0050	50	10
15.304.0065	65	10
15.304.0075	75	10
15.304.0100	100	6
15.304.0125	125	4
15.304.0150	150	4



Separating Funnels



Making Liquid Separations Simple & Effective
Supertek Range of Separating Funnels

Separating Funnel With I/C Polypropylene Stopper, Squibb Shape

- In Compliance to IS 1575/ISO 4800 Standard. Printed in white color
- Made of Borosilicate 3.3 glass
- Squibb shape
- Generally used in the separation phase

Cat. No.	Capacity, ml	Neck Size	Stopcock Type	Pack Size
15.401.0030	30*	14/23	Glass Screw Cap	2
15.401.0060	60	19/26	Glass Screw Cap	2
15.401.0125	125	19/26	Glass Screw Cap	2
15.401.0250	250	29/32	Glass Screw Cap	2
15.401.0500	500	29/32	Glass Screw Cap	2
15.401.1000	1000	29/32	Glass Screw Cap	1
15.401.2000	2000	29/32	Glass Screw Cap	1
15.403.0030	30*	14/23	PTFE Needle valve	2
15.403.0060	60	19/26	PTFE Needle valve	2
15.403.0125	125	19/26	PTFE Needle valve	2
15.403.0250	250	29/32	PTFE Needle valve	2
15.403.0500	500	29/32	PTFE Needle valve	2
15.403.1000	1000	29/32	PTFE Needle valve	1
15.403.2000	2000	29/32	PTFE Needle valve	1
15.405.0030	30*	14/23	PTFE Key	2
15.405.0060	60	19/26	PTFE Key	2
15.405.0125	125	19/26	PTFE Key	2
15.405.0250	250	29/32	PTFE Key	2
15.405.0500	500	29/32	PTFE Key	2
15.405.1000	1000	29/32	PTFE Key	1
15.405.2000	2000	29/32	PTFE Key	1

*Non IS/ISO Size

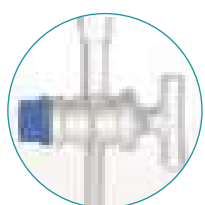

Glass Stopcock



Rotaflo Stopcock

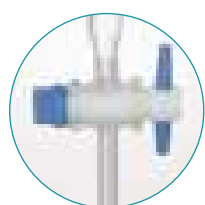

PTFE Key Stopcock

Separatory Funnel is made of Polypropylene
Page No. 196

Amber Colour Separating Funnels, Interchangeable Stopper, Squib Shape, Plain Stem

Cat. No	Capacity ml.	Pack Size	Stopcock Type
15.417.0030	30	4	Glass Stopcock
15.417.0060	60	4	Glass Stopcock
15.417.0125	125	4	Glass Stopcock
15.417.0250	250	4	Glass Stopcock
15.417.0500	500	4	Glass Stopcock
15.417.1000	1000	4	Glass Stopcock
15.417.2000	2000	2	Glass Stopcock
15.418.0030	30	4	PTFE Key
15.418.0060	60	4	PTFE Key
15.418.0125	125	4	PTFE Key
15.418.0250	250	4	PTFE Key
15.418.0500	500	4	PTFE Key
15.418.1000	1000	4	PTFE Key
15.418.2000	2000	2	PTFE Key

Separating Funnel With I/C Polypropylene Stopper, Globe Shape

• In Compliance to IS 1575/ISO 4800 Standard

Cat. No	Capacity, ml	Neck Size	Stopcock Type	Pack Size
15.421.0025	25*	14/23	Glass Screw Cap	2
15.421.0050	50	19/26	Glass Screw Cap	2
15.421.0100	100	19/26	Glass Screw Cap	2
15.421.0250	250	29/32	Glass Screw Cap	2
15.421.0500	500	29/32	Glass Screw Cap	2
15.421.1000	1000	29/32	Glass Screw Cap	1
15.421.2000	2000	29/32	Glass Screw Cap	1
15.421.3000	3000	34/35	Glass Screw Cap	1
15.421.5000	5000	34/35	Glass Screw Cap	1
15.421.9910	10000	34/35	Glass Screw Cap	1
15.421.9920	20000	34/35	Glass Screw Cap	1
15.423.0025	25*	14/23	PTFE Needle Valve	2
15.423.0050	50	19/26	PTFE Needle Valve	2
15.423.0100	100	19/26	PTFE Needle Valve	2
15.423.0250	250	29/32	PTFE Needle Valve	2
15.423.0500	500	29/32	PTFE Needle Valve	2
15.423.1000	1000	29/32	PTFE Needle Valve	1
15.423.2000	2000	29/32	PTFE Needle Valve	1
15.425.0025	25*	14/23	PTFE Key	2
15.425.0050	50	19/26	PTFE Key	2
15.425.0100	100	19/26	PTFE Key	2
15.425.0250	250	29/32	PTFE Key	2
15.425.0500	500	29/32	PTFE Key	2
15.425.1000	1000	29/32	PTFE Key	1
15.425.2000	2000	29/32	PTFE Key	1

*Non IS/ISO Size



Dropping Funnel, Cylindrical With I/C Polypropylene Stopper

• In Compliance to IS 1575/ISO 4800 Standard. Printed in white color

Cat. No.	Capacity, ml	Neck Size	Pack Size	Stopcock Type
15.448.0002	25*	14/23	2	Glass Screw Cap
15.448.0005	50	14/23	2	Glass Screw Cap
15.448.0015	100	14/23	2	Glass Screw Cap
15.448.0020	100	29/32	2	Glass Screw Cap
15.448.0025	250	29/32	1	Glass Screw Cap
15.448.0030	500	29/32	1	Glass Screw Cap
15.448.0035	1000	29/32	1	Glass Screw Cap

*Non IS/ISO Size

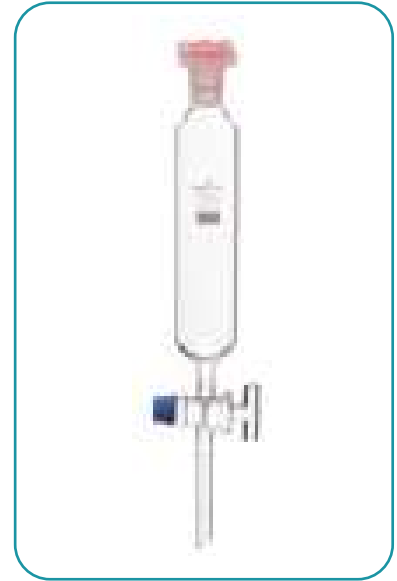

Dropping Funnel, Cylindrical, Graduated With I/C Polypropylene Stopper

• In Compliance to IS 1575/ISO 4800 Standard. Printed in white color

Cat. No.	Capacity, ml	Neck Size	Pack Size	Stopcock Type
15.465.0002	25*	14/23	2	Glass Screw Cap
15.465.0005	50	14/23	2	Glass Screw Cap
15.465.0015	100	14/23	2	Glass Screw Cap
15.465.0020	100	29/32	2	Glass Screw Cap
15.465.0025	250	29/32	1	Glass Screw Cap
15.465.0030	500	29/32	1	Glass Screw Cap
15.465.0035	1000	29/32	1	Glass Screw Cap
15.468.0002	25*	14/23	2	PTFE Needle Valve
15.468.0005	50	14/23	2	PTFE Needle Valve
15.468.0015	100	14/23	2	PTFE Needle Valve
15.468.0020	100	29/32	2	PTFE Needle Valve
15.468.0025	250	29/32	1	PTFE Needle Valve
15.468.0030	500	29/32	1	PTFE Needle Valve
15.468.0035	1000	29/32	1	PTFE Needle Valve

*Non IS/ISO Size



Dropping Funnel, Cylindrical, With Stem Inside Cone, Graduated

• In Compliance to DIN ISO 4800 Standard. Printed in white color

Cat. No.	Capacity, ml	Neck Size	Pack Size	Stopcock Type
15.472.0005	50	14/23	2	Glass stopcock
15.472.0010	50	29/32	2	Glass stopcock
15.472.0015	100	14/23	2	Glass stopcock
15.472.0020	100	29/32	2	Glass stopcock
15.472.0025	250	29/32	1	Glass stopcock
15.472.0030	500	29/32	1	Glass stopcock
15.472.0035	1000	29/32	1	Glass stopcock
15.474.0005	50	14/23	2	PTFE Key
15.474.0010	50	29/32	2	PTFE Key
15.474.0015	100	14/23	2	PTFE Key
15.474.0020	100	29/32	2	PTFE Key
15.474.0025	250	29/32	1	PTFE Key
15.474.0030	500	29/32	1	PTFE Key
15.474.0035	1000	29/32	1	PTFE Key



Pressure Equalizing Funnel, Cylindrical, With Polypropylene Stopper, Stem With Cone

• Printed in white color

Cat. No.	Capacity, ml	Socket Size	Cone Size	Pack Size	Stopcock Type
15.480.0005	50	14/23	14/23	2	Glass Screw Cap
15.480.0010	50	29/32	29/32	2	Glass Screw Cap
15.480.0015	100	14/23	14/23	2	Glass Screw Cap
15.480.0020	100	29/32	29/32	2	Glass Screw Cap
15.480.0025	250	29/32	29/32	1	Glass Screw Cap
15.480.0030	500	29/32	29/32	1	Glass Screw Cap
15.482.0005	50	14/23	14/23	2	PTFE Key
15.482.0010	50	29/32	29/32	2	PTFE Key
15.482.0015	100	14/23	14/23	2	PTFE Key
15.482.0020	100	29/32	29/32	2	PTFE Key
15.482.0025	250	29/32	29/32	1	PTFE Key
15.482.0030	500	29/32	29/32	1	PTFE Key



Pressure Equalizing Funnel, Pear Shape, Glass Stopcock and Stem With Cone

• Printed in white color

Cat. No.	Capacity, ml	Socket Size	Cone Size	Pack Size
15.485.0050	50	14/23	14/23	1
15.485.0100	100	14/23	14/23	1
15.485.0250	250	29/32	29/32	1
15.485.0250B	250	24/29	24/29	1
15.485.0500	500	29/32	29/32	1
15.485.0500B	500	24/29	24/29	1



Dessicator, With Cover, Neutral Glass With Porcelain Plate

Cat. No.	Dia., mm	Pack Size
19.101.0160	160	1
19.101.0210	210	1
19.101.0250	250	1
19.101.0300	300	1



Dessicator, Vacuum Neutral Glass With Porcelain Plate

Cat. No.	Dia., mm	Pack Size
19.104.0160	160	1
19.104.0210	210	1
19.104.0250	250	1
19.104.0300	300	1



Dish, Crystallizing, Without Spout

- Fire-polished rims to reduce chipping
- High resistance to chemical attack and thermal shock

Cat. No.	O.D., mm	Ht., mm	Pack size
19.105.0040	40	25	4
19.105.0050	50	30	4
19.105.0060	60	35	4
19.105.0070	70	40	4
19.105.0080	80	45	4
19.105.0100	100	50	4
19.105.0150	150	75	1
19.105.0190	190	100	1



Dish, Crystallizing, With Spout

- Fire-polished rims to reduce chipping
- High resistance to chemical attack and thermal shock

Cat. No.	O.D., mm	Ht., mm	Pack size
19.108.0040	40	25	4
19.108.0050	50	30	4
19.108.0060	60	35	4
19.108.0070	70	40	4
19.108.0080	80	45	4
19.108.0100	100	50	4
19.108.0150	150	75	1
19.108.0190	190	100	1



Dishes Evaporating, Flat Bottom, With Spout, Made of 3.3 Borosilicate Glass High Resistance to Thermal Shock and Chemical Attack

Cat. No.	Approx. O.D. x Ht. mm.	Pack size
19.109.0010	80 x 45	10
19.109.0020	105 x 55	10
19.109.0030	150 x 80	10
19.109.0040	200 x 100	5



Amber Color Petri Dishes, Boro3.3 Glass

- Ideal for use in Lab work
- Even wall thickness
- Can be sterilized repeatedly

Cat. No.	Size DxH (mm)	Top IDxH (mm)	Bottom ODxH(mm)	Pack Size
19.111.0050D	50x17	52x15	50x17	10
19.111.0075	75x17	78x15	75x17	10
19.111.0080D	80x17	83x15	80x17	10
19.111.0100D	100x17	103x15	100x17	10

Best Seller



Petri Dish, Complete With Cover Boro 3.3 Glass

- Ideal for use in Lab work
- Even wall thickness
- Can be sterilized repeatedly

Cat. No.	Size DxH (mm)	Top IDxH (mm)	Bottom ODxH(mm)	Pack Size
19.112.0050D	50x17	52x15	50x17	10
19.112.0075	75x17	78x15	75x17	10
19.112.0080D	80x17	83x15	80x17	10
19.112.0100D	100x17	103x15	100x17	10
19.112.0150D	150x20	153x17	150x20	10
19.112.0200D	200x20	203x17	200x20	10



Glass Spreader

Cat. No.	Description	Pack Size
19.114.0005	Spreader L Shape	10
19.114.0015	Spreader Lower Portion at angle	10
19.114.0025	Spreader Triangular 50mm	10



Gas Generator, Kipp's With Ground Glass Joints - Complete With Delivery Tube, Thistle Funnel And Glass Stopcock

- Manufactured from Borosilicate 3.3 glass
- Used to produce common gases
- Simple to operate and assemble

Cat. No.	Capacity, ml	Pack Size
12.160.0250	250	1
12.160.0500	500	1
12.160.1000	1000	1

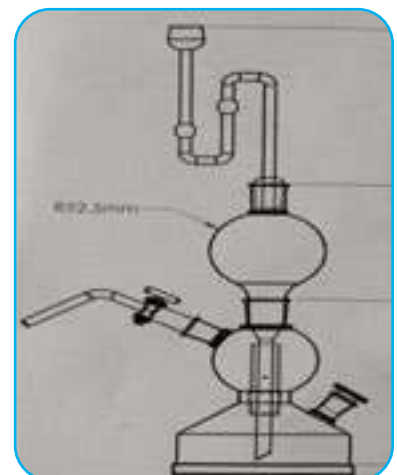

Sintered Glassware



**Solid Liquid Separations ?
Choose Supertek Sintered Glassware**

Sintered Glass

Sintered Glass Filter Disc

Used extensively for filtration of both liquids or gases. In four ranges as detailed below.

Porosity Pore Size General Use

Grade

1	90-150	Coarse precipitate, filtration, gas dispersion, coarse grain material filtration.
2	40-90	Medium & crystalline precipitate filtration, medium filtration & washing of gases
3	15-40	Fine gas filtration and dispersion, mercury filtration, fine grain material filtration, collection of fine precipitates. Analytical work with medium precipitates.
4	5-15	Valves of mercury collection of very fine precipitates. Analytical work with fine precipitates.

Crucible, Gooch Type With Sintered Disc of Porosity Grade 1 or 2 or 3 or 4

Cat. No.	Capacity, ml	Disc, dia. mm	Pack Size	Grade
18.101.0005	15	20	10	Grade 1
18.101.0010	30	30	10	Grade 1
18.101.0015	50	40	10	Grade 1
18.101.0020	15	20	10	Grade 2
18.101.0025	30	30	10	Grade 2
18.101.0030	50	40	10	Grade 2
18.101.0035	15	20	10	Grade 3
18.101.0040	30	30	10	Grade 3
18.101.0045	50	40	10	Grade 3
18.101.0050	15	20	10	Grade 4
18.101.0055	30	30	10	Grade 4
18.101.0060	50	40	10	Grade 4



Buchner Funnel With Sintered Disc of Porosity Grade 1 or 2 or 3 or 4

Cat. No.	Capacity, ml	Disc, dia. mm	Pack Size	Grade
18.104.0005	35	30	2	Grade 1
18.104.0010	80	40	2	Grade 1
18.104.0020	200	65	1	Grade 1
18.104.0025	500	90	1	Grade 1
18.104.0030	1000	120	1	Grade 1
18.104.0040	35	30	2	Grade 2
18.104.0045	80	40	2	Grade 2
18.104.0055	200	65	1	Grade 2
18.104.0060	500	90	1	Grade 2
18.104.0065	1000	120	1	Grade 2
18.104.0075	35	30	2	Grade 3
18.104.0080	80	40	2	Grade 3
18.104.0090	200	65	1	Grade 3
18.104.0095	500	90	1	Grade 3
18.104.0100	1000	120	1	Grade 3
18.104.0110	35	30	2	Grade 4
18.104.0115	80	40	2	Grade 4
18.104.0125	200	65	1	Grade 4
18.104.0130	500	90	1	Grade 4
18.104.0135	1000	120	1	Grade 4



Buchner Funnel With Sintered Disc of Porosity Grade 1 or 2 or 3 or 4, Cone on Stem

Cat. No.	Capacity, ml	Disc, dia. mm	Cone Size	Pack Size	Grade
18.108.0005	35	30	14/23	2	Grade 1
18.108.0007	35	30	19/26	2	Grade 1
18.108.0010	80	40	14/23	2	Grade 1
18.108.0012	80	40	19/26	2	Grade 1
18.108.0020	200	65	19/26	1	Grade 1
18.108.0022	200	65	24/29	1	Grade 1
18.108.0025	500	90	19/26	1	Grade 1
18.108.0027	500	90	29/32	1	Grade 1
18.108.0030	1000	120	24/29	1	Grade 1
18.108.0032	1000	120	29/32	1	Grade 1
18.108.0035	35	30	14/23	2	Grade 2
18.108.0037	35	30	19/26	2	Grade 2
18.108.0040	80	40	14/23	2	Grade 2
18.108.0042	80	40	19/26	2	Grade 2
18.108.0050	200	65	19/26	1	Grade 2
18.108.0052	200	65	24/29	1	Grade 2
18.108.0055	500	90	19/26	1	Grade 2
18.108.0057	500	90	29/32	1	Grade 2
18.108.0060	1000	120	24/29	1	Grade 2
18.108.0062	1000	120	29/32	1	Grade 2
18.108.0065	35	30	14/23	2	Grade 3
18.108.0067	35	30	19/26	2	Grade 3
18.108.0070	80	40	14/23	2	Grade 3
18.108.0072	80	40	19/26	2	Grade 3
18.108.0080	200	65	19/26	1	Grade 3
18.108.0082	200	65	24/29	1	Grade 3
18.108.0085	500	90	19/26	1	Grade 3
18.108.0087	500	90	29/32	1	Grade 3
18.108.0090	1000	120	24/29	1	Grade 3
18.108.0092	1000	120	29/32	1	Grade 3
18.108.0095	35	30	14/23	2	Grade 4
18.108.0097	35	30	19/26	2	Grade 4
18.108.0100	80	40	14/23	2	Grade 4
18.108.0102	80	40	19/26	2	Grade 4
18.108.0110	200	65	19/26	1	Grade 4
18.108.0112	200	65	24/29	1	Grade 4
18.108.0115	500	90	19/26	1	Grade 4
18.108.0117	500	90	29/32	1	Grade 4
18.108.0120	1000	120	24/29	1	Grade 4
18.108.0122	1000	120	29/32	1	Grade 4

Conical Filter, (Hirsch Type) With Sintered Disc of Porosity Grade 1 or 2 or 3 or 4

Cat No.	Capacity, ml	Disc, dia. mm	Pack Size	Grade
18.112.0005	20	20	2	Grade 1
18.112.0010	60	30	2	Grade 1
18.112.0015	175	30	2	Grade 1
18.112.0020	20	20	2	Grade 2
18.112.0025	60	30	2	Grade 2
18.112.0030	175	30	2	Grade 2
18.112.0035	20	20	2	Grade 3
18.112.0040	60	30	2	Grade 3
18.112.0045	175	30	2	Grade 3
18.112.0050	20	20	2	Grade 4
18.112.0055	60	30	2	Grade 4
18.112.0060	175	30	2	Grade 4



Sintered Glass Filter Tube With Sintered Disc Sealed In Center, Porosity Grade 1 or 2 or 3 or 4

Cat. No.	Disc, dia. mm	Pack Size	Grade
18.116.0005	10	2	Grade 1
18.116.0010	20	2	Grade 1
18.116.0015	30	2	Grade 1
18.116.0020	45	2	Grade 1
18.116.0025	50	2	Grade 1
18.116.0030	90	2	Grade 1
18.116.0035	10	2	Grade 2
18.116.0040	20	2	Grade 2
18.116.0045	30	2	Grade 2
18.116.0050	45	2	Grade 2
18.116.0055	50	2	Grade 2
18.116.0060	90	2	Grade 2
18.116.0065	10	2	Grade 3
18.116.0070	20	2	Grade 3
18.116.0075	30	2	Grade 3
18.116.0080	45	2	Grade 3
18.116.0085	50	2	Grade 3
18.116.0090	90	2	Grade 3
18.116.0095	10	2	Grade 4
18.116.0100	20	2	Grade 4
18.116.0105	30	2	Grade 4
18.116.0110	45	2	Grade 4
18.116.0115	50	2	Grade 4
18.116.0120	90	2	Grade 4



Filtering Tube With Sintered Disc, Sealed in Center With Reduced Ends, (Pipe Line Filter) Porosity Grade 1 or 2 or 3 or 4

Cat. No.	Disc, dia. mm	Pack Size	Grade
18.120.0005	30	2	Grade 1
18.120.0010	40	2	Grade 1
18.120.0015	50	2	Grade 1
18.120.0020	65	2	Grade 1
18.120.0025	90	2	Grade 1
18.120.0030	30	2	Grade 2
18.120.0035	40	2	Grade 2
18.120.0040	50	2	Grade 2
18.120.0045	65	2	Grade 2
18.120.0050	90	2	Grade 2
18.120.0055	30	2	Grade 3
18.120.0060	40	2	Grade 3
18.120.0065	50	2	Grade 3
18.120.0070	65	2	Grade 3
18.120.0075	90	2	Grade 3
18.120.0080	30	2	Grade 4
18.120.0085	40	2	Grade 4
18.120.0090	50	2	Grade 4
18.120.0095	65	2	Grade 4
18.120.0100	90	2	Grade 4



Filtering Apparatus Complete With Filter Flask, With Socket, Buchner Funnel With Sintered Disc Cone. of Porosity Grade 1 Having Cone

Cat. No.	Flask Capacity, ml	Crucible Capacity, ml	Joint	Pack Size
18.122.0250	250	80	24/29	1
18.122.0500	500	200	24/29	1
18.122.1000	1000	500	29/32	1
18.122.2000	2000	1000	29/32	1



Glass Filter Holder With Silicon Stopper **A**

- Made of borosilicate 3.3 glass with fritted glass filter base
- The filtration base has a high quality silicon stopper
- Anodised aluminium spring clamp for good grip
- The filter size is 25mm & 47 mm
- Facilitates analysis of particulate or biological contamination of vacuum filtering liquid
- The scaled funnels simplify dosing and analysis

Cat No	Membrane Dia.	Funnel Capacity, ml	Flask Capacity, ml	Pack Size
18.144.0125	25	15	125	1
18.144.1000	47	300	1000	1
18.144.2000	47	300	2000	1



Spares For Glass Filter Holder With Silicon Stopper

Cat No	Capacity ml	Description	Pack Size
18.144.0125-1	15	Funnel for 25 mm filter holder	1
18.144.0125-2	25	Clamp for 25 mm filter holder	1
18.144.0125-3	25	Fritted glass base with stopper for 25 mm filter holder	1
18.144.0125-4	125	Flask for 25 mm filter holder	1
18.144.1000-1	300 B	Funnel for 47 mm filter holder	1
18.144.1000-2	47 C	Clamp for 47 mm filter holder	1
18.144.1000-3	47 D	Fritted glass base with stopper for 47 mm filter holder	1
18.144.1000-4	1000	Flask for 47 mm filter holder	1
18.144.2000-1	2000	Flask for 47 mm filter holder	1

All Glass Filter Holder - 47 mm, Filtration Assembly

- Made of borosilicate 3.3 glass with fritted glass filter base
- Anodised aluminium spring clamp
- The filter size is 47mm
- Used for filtration of HPLC solvents and aqueous mobile phase solutions and buffers
- The scaled funnels simplify dosing and analysis

Cat. No.	Membrane Dia. mm	Funnel Capacity, ml	Flask Capacity, ml	Pack Size
18.147.0500	47	300	500	1
18.147.1000	47	300	1000	1
18.147.2000	47	300	2000	1

Spares For All Glass Filter Holder - 47 mm, Filtration Assembly

Cat. No.	Specification	Description	Pack Size
18.147.0500-1	300 ml	Funnel for 47 mm filter holder	1
18.147.0500-2	47 mm	Clamp for 47 mm filter holder	1
18.147.0500-3	47 mm	Fritted glass base with Joint for 47 mm filter holder	1
18.147.0500-4	500 ml	Flask for 47 mm filter holder	1
18.147.1000-4	1000 ml	Flask for 47 mm filter holder	1
18.147.2000-4	2000 ml	Flask for 47 mm filter holder	1



Bottle Filtration Assembly

- Supertek Bottle Filtration Assembly is the right product for filtering Solvents, Chemical Solutions, Biological Solutions without the risk of Spillage during transferring it from flask. Direct Filtration into the bottle also ensures freedom from contamination.
- The Assembly is fully Autoclavable.

Components of the Assembly

Sr.No	Item Name	Material	Size
A	Funnel	Borosilicate Glass	300 ml
B	Membrane Support	Borosilicate Glass	47 MM
C	Clamp	Aluminium	
D	Stopper	Silicon	
E	Adappter	Polypropylene	GL 45
F	Bottle	Borosilicate	1000/2000/5000 ml

Cat. No.	Capacity, ml	Pack Size
18.150.1000	1000	1
18.150.2000	2000	1
18.150.3000	5000	1

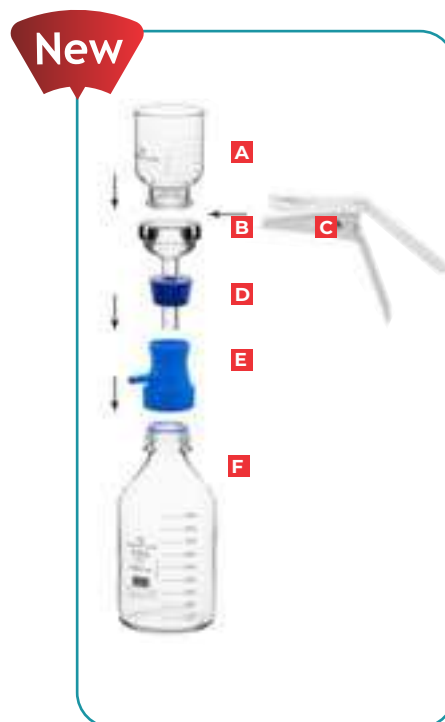

Filter Holders, Stainless Steel (To Hold Membrane Filters)

- Material - Stainless Steel

Cat. No.	Description	Pack Size
18.200.0010	Vacuum Filter Holder 47 mm	1
18.210.0030	3 Branch Sterility Test, 47 mm	1
18.210.0060	6 Branch Sterility Test, 47 mm	1



Supertek E-Funnel

- Supertek E-funnel is an easy to use pre-sterilized, individually packed disposable filtration device, specially designed to help facilitate and speed up microbial analysis of antibiotics and drugs containing bacteriostats in pharmaceutical API and formulation industries.

E-Funnel has a convenient design with a detachable 100ml funnel and pluggable bottom for ease of sample collection and transfer to laboratory. In-built 0.45µm Edge Hydrophobic Cellulose Nitrate membrane.

Specifications:

- Pore Size : 0.45µm
- Water Flow Rate : 20ml/min at 250mm Hg Vacuum
- Sterilization : EO
- Diameter : 47mm

Cat. No.	Pack Size
18.234.0100	100



Supertek Vacuum Filter Holder

- Material - Polysulfone (PSU)
- Filter Size – 47 mm
- Capacity – 250ml
- Seal – Silicon
- Stop Cork- 8 No. Size

Cat. No.	Pack Size
18.238.0250	1



Oil Free Portable Vacuum Pumps (Diaphragm Type)

Cat. No.	Flow (LPM)	Vacuum	Motor (hp)	Pressure (Psig)	Pack Size
18.240.0010	15	22"	1/20	25	1
18.240.0020	15	27"	1/16	35	1
18.240.0030	15	22"	1/8	25	1
18.240.0040	50	27"	1/4	55	1
Chemical Resistant Pump, value made of Teflon					
18.242.0010	30	22	1/8	35	1
18.242.0020	60	27	1/4	55	1
Accessories					
18.242.0010-1	CRP Vacuum gauge with regulator				
18.242.0010-2	Moisture Trap				



Supertek Sterility Test Unit Complete Kit (Inbuilt Clamp)

- Filter Funnel S.S.316 with inbuilt Aluminium Clamp
- S. S. lid & Neoprene Cork
- Manifold three place S.S. with PTFE valve/2 way
- Membrane Filter 47 mm/0.45 µm, pack of 100
- Vacuum flask 1 litre
- Vacuum pump diaphragm type-oil free single stage
- Air vent filter- Hydrophobic PTFE 50 mm/ 0.2 µm
- Flexible Silicon Tubing 2 mtr.

Cat. No.	Funnel Cap.(ml)	Pack Size
18.245.0300	300	1
18.245.0500	500	1

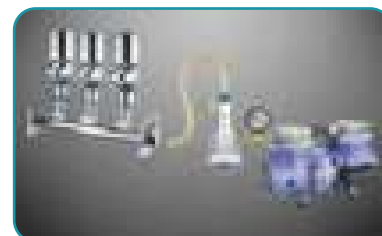

Supertek Sterility Test Unit Complet Kit (External Clamp)

- Filter Funnel S.S.316 with External Aluminum Clamp (o-ring less)
- S. S. lid & Neoprene Cork
- Manifold three place S.S. with PTFE valve/2 way
- Membrane Filter 47 mm/0.45 µm, pack of 100
- Vacuum flask 1 litre
- Vacuum pump diaphragm type-oil free
- Air vent filter- Hydrophobic PTFE 50 mm/ 0.2 µm
- Flexible Silicon Tubing 2 mtr.

Cat. No.	Funnel Cap.(ml)	Pack Size
18.248.0300	300	1
18.248.0500	500	1

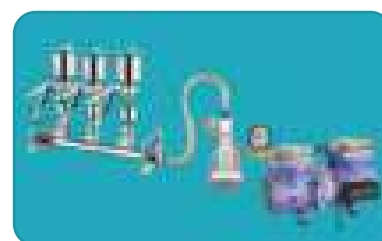

Bottles



Supertek Bottles
Your choice for Safe Containment

Bottles

Bottle, Reagent Interchangeable Flat Head Glass Stopper, Narrow Mouth, Clear

- In Compliance to ISO 4796(Part II) /I.S.1388 (Part II) Standard
- These narrow mouth reagent storage bottles have a sturdy ground neck
- Labeling field for easy marking
- Manufactured from 3.3 Borosilicate Glass for corrosion-free performance
- Printed in white color.

Cat. No.	Capacity, ml	Neck Stopper size	O.D.Ht., mm	Pack Size
12.150.0030	30	14/23	36x78	12
12.150.0060	60*	14/23	42x90	12
12.150.0100	100	14/23	55x95	12
12.150.0125	125*	19/26	55x120	12
12.150.0250	250	19/26	70x128	12
12.150.0500	500	24/29	86x162	6
12.150.1000	1000	29/32	107x198	4
12.150.2000	2000	29/32	133x246	2
12.150.3000	3000	34/35	150x300	1

*Non ISO/IS Sizes



Bottle, Reagent Interchangeable Glass Stopper, Narrow Mouth, Amber

- In Compliance to ISO 4796(Part II) /I.S.1388(Part II) Standard
- These narrow mouth reagent storage bottles have a sturdy ground neck
- Labeling field for easy marking
- Manufactured from 3.3 Borosilicate Glass for corrosion-free performance
- The uniform Amber colour is durable and has high chemical resistance
- Used with light-sensitive media and for the storage of substances
- Printed in white color.

Cat. No.	Capacity, ml	Neck Stopper size	O.D.Ht., mm	Pack Size
12.151.0030	30*	14/23	36x78	12
12.151.0060	60*	14/23	42x90	12
12.151.0100	100	14/23	55x95	12
12.151.0125	125*	19/26	55x120	12
12.151.0250	250	19/26	70x128	12
12.151.0500	500	24/29	86x162	6
12.151.1000	1000	29/32	107x198	4
12.151.2000	2000	29/32	133x246	2

*Non ISO/IS Sizes



Bottle, Reagent, Heavy Duty, Graduated with Interchangeable Flat Head Glass Stopper, Narrow Mouth, Clear

- These narrow mouth reagent storage bottles have a sturdy ground neck
- Labeling field for easy marking
- Manufactured from 3.3 Borosilicate Glass for corrosion-free performance
- Printed in white color

Cat. No.	Capacity, ml	Neck Stopper size	O.D. Ht., mm	Pack Size
12.180.0100	100	14/23	56x100	10
12.180.0250	250	19/26	70x145	10
12.180.0500	500	24/29	86x173	10
12.180.1000	1000	29/32	101x225	6
12.180.2000	2000	29/32	136x260	2



Bottle, Reagent, Heavy Duty, Graduated with Interchangeable Glass Stopper, Narrow Mouth, Amber

- These narrow mouth reagent storage bottles have a sturdy ground neck
- Labeling field for easy marking
- Manufactured from 3.3 Borosilicate Glass for corrosion-free performance
- The uniform Amber colour is durable and has high chemical resistance
- Used with light-sensitive media and for the storage of substances
- Printed in white color

Cat. No.	Capacity, ml	Neck Stopper size	O.D. Ht., mm	Pack Size
12.181.0100	100	14/23	56x100	10
12.181.0250	250	19/26	70x145	10
12.181.0500	500	24/29	86x173	10
12.181.1000	1000	29/32	101x225	6
12.181.2000	2000	29/32	136x260	2



Bottle, Reagent, With Screw Cap, Clear

- In Compliance to ISO 4796(Part I) / I.S.1388(Part I) Standard
- Labeling field for easy marking
- Manufactured from 3.3 Borosilicate Glass for corrosion-free performance
- Pouring ring for drip-free operation
- The screw caps and pouring ring are made of high grade PP
- The bottles, screw caps and pouring rings can be sterilized and autoclavable
- Printed in white color

Cat. No.	Capacity, ml	Thread Specification	O.D. Ht., mm	Pack Size
12.108.0010	10**	GL 25	34x50	10
12.108.0025	25 [†]	GL 25	36x70	10
12.108.0050	50 [†]	GL 32	46x87	10
12.108.0100	100	GL 45	56x100	10
12.108.0250	250	GL 45	70x138	10
12.108.0500	500	GL 45	86x176	10
12.108.1000	1000	GL 45	101x225	6
12.108.2000	2000	GL 45	136x260	2
12.108.3000	3000**	GL 45	166x285	1
12.108.5000	5000	GL 45	181x330	1
12.108.9910	10000	GL 45	227x410	1
12.108.9920	20000	GL 45	288x505	1

[†] Without Pouring Ring

** Non ISO/IS Sizes



Bottle, Reagent, With Screw Cap, Amber

- In Compliance to ISO 4796(Part I) /I.S.1388(Part I) Standard.
- Labeling field for easy marking
- Manufactured from 3.3 Borosilicate Glass for corrosion-free performance
- Pouring ring for drip-free operation
- The screw caps and pouring ring are made of high grade PP
- The bottles, screw caps and pouring rings can be sterilized and autoclavable
- Printed in white color

Cat. No.	Capacity, ml	Thread Specification	O.D. Ht., mm	Pack Size
12.112.0010	10*	GL 25	34x50	10
12.112.0025	25	GL 25	36x70	10
12.112.0050	50*	GL 32	46x87	10
12.112.0100	100	GL 45	56x100	10
12.112.0250	250	GL 45	70x138	10
12.112.0500	500	GL 45	86x176	10
12.112.1000	1000	GL 45	101x225	6
12.112.2000	2000	GL 45	136x260	2
12.112.3000	3000**	GL 45	166x285	1
12.112.5000	5000	GL 45	181x330	1
12.112.9910	10000	GL 45	227x410	1
12.112.9920	20000	GL 45	288x505	1

Without Pouring Ring

**Non ISO/IS Sizes



Bottle, Reagent, Long Neck, Heavy Duty with Screw Cap, Clear

- In Compliance to ISO 4796(Part I) /I.S.1388(Part I) Standard
- Special Shape for Easy holding & comfortable movement
- Labeling field for easy marking
- Manufactured from 3.3 Borosilicate Glass for corrosion-free performance
- The screw caps and pouring ring are made of high grade PP
- The bottles, screw caps and pouring rings can be sterilized and autoclavable
- Printed in white color

Cat. No.	Capacity, ml	Thread Specification	O.D. Ht., mm	Pack Size
12.109.3000	3000	GL-45	158x300	1
12.109.5000	5000	GL-45	181x330	1



Reagent Bottle Clear, Extra Wide Mouth With Polypropylene Screw Cap And With Pouring Ring, Repeatedly Autoclavable, Graduated

- Labeling field for easy marking
- Manufactured from 3.3 Borosilicate Glass for corrosion-free performance

Cat. No.	Capacity ml.	DIN Thread	Pack Size
12.106.5000	5000	GL80	1
12.106.9910	10000	GL80	1
12.106.9920	20000	GL80	1



Reagent Bottle Amber Colour, Extra Wide Mouth With Polypropylene Screw Cap & Pouring Ring, Repeatedly Autoclaveable, Graduated

- Labeling field for easy marking
- Manufactured from 3.3 Borosilicate Glass for corrosion-free performance
- The uniform Amber colour is durable and has high chemical resistance
- Used with light-sensitive media and for the storage of substances

Cat. No.	Capacity ml.	DIN Thread	Pack Size
12.107.5000	5000	GL80	1
12.107.9910	10000	GL80	1
12.107.9920	20000	GL80	1



Caps, PP Screw Cap with Pouring Ring for Laboratory Reagent Bottles

- Autoclavable upto 140°C
- Made of high grade polypropylene

Cat. No.	Colour	DIN Thread	Pack Size
12.103.0005	Blue	GL 45	10
12.103.0010	Orange	GL 45	10
12.103.0015	Yellow	GL 45	10
12.103.0020	Green	GL 45	10
12.103.0025	Grey	GL 45	10
12.103.0030	Blue	GL 25	10
12.103.0035	Blue	GL 32	10



Bottle, McCartney (Bijou) Narrow Mouth, Clear Neutral Glass, Autoclavable, With Aluminium Screw Cap and Rubber Liner

Cat No.	Capacity, ml	Pack Size
12.124.0007	7	500
12.124.0014	14	400

Bottle, Mc Cartney (Bijou) Universal, Wide Mouth, Clear Neutral Glass, Autoclaveable, With Aluminium Cap And Rubber Washer

Cat No.	Capacity, ml	Pack Size
12.128.0028	28	400



Bottle, Dropping Bottle With Rubber Teat, Dropping Pipette Ground Into Bottle Neck, Clear

- Labeling field for easy marking
- Manufactured from 3.3 Borosilicate Glass for corrosion-free performance
- Supplied with interchangeable ground joint transparent pipette with rubber teat
- Printed in white color

Cat. No.	Capacity ml.	Pack Size
12.116.0030	30	12
12.116.0060	60	12
12.116.0125	125	12
12.116.0250	250	12



Bottle, Dropping Bottle With Rubber Teat, Dropping Pipette Ground Into Bottle Neck, Amber

- Labeling field for easy marking
- Manufactured from 3.3 Borosilicate Glass for corrosion-free performance
- The uniform Amber colour is durable and has high chemical resistance
- Supplied with interchangeable ground joint transparent pipette with rubber teat
- Printed in white color

Cat. No.	Capacity ml.	Pack Size
12.120.0030	30	12
12.120.0060	60	12
12.120.0125	125	12
12.120.0250	250	12



Bottles, Solution, Amber, Tooled Neck

- Labeling field for easy marking
- Manufactured from 3.3 Borosilicate Glass for corrosion-free performance
- Properties within the bottle remain unchanged, as the colour is applied only on the external surface
- Protects media from light radiation with a wave-length between 300nm and 500nm
- Ideal for use with light-sensitive media and for long-term storage of substances

Cat. No.	Capacity ml.	Approx Neck I. D. mm	Pack Size
12.110.0250	250	18	10
12.110.0500	500	23	10
12.110.1000	1000	28	6
12.110.2000	2000	33	2



Bottles, Solution, Plain, Tooled Neck

- Labeling field for easy marking
- Manufactured from 3.3 Borosilicate Glass for corrosion-free performance

Cat. No.	Capacity ml.	Neck I. D. mm	Pack Size
12.129.0250	250	18	10
12.129.0500	500	23	10
12.129.1000	1000	28	10
12.129.2000	2000	33	10
12.129.3000	3000	44	1
12.129.5000	5000	44	1
12.129.9910	10000	54	1
12.129.9920	20000	54	1



Roux, Culture Bottle, Off-Set Neck

- Complies with IS6942
- Neck ID-25mm approx
- It withstands repeated sterilization (wet or dry)

Cat. No.	Capacity ml.	Pack Size
12.122.1000	1000	20



BOD Bottles

- These bottles are used for determining oxygen demand in samples of sewage, industrial waste, polluted water or any other sample, diluted samples are incubated in the bottles and analyzed. Its stoppers are designed to prevent air entrapment and flared mouth forms a water seal to prevent intrusion of air.
- Supertek brand BOD bottles are manufactured from Boro 3.3 glass as per ASTM E-438 type 1, Class A standard. These bottles have a large permanent marking space for labeling of bottle numbers.

BOD Bottles

- In Compliance to I.S.9213
- Printed in white color.

Cat. No.	Capacity ml.	Pack Size
12.174.0060	60	6
12.174.0125	125*	6
12.174.0300	300	2

*Non ISO/IS Sizes



These bottles are unnumbered. If required bottles with sequence number can also be provided at extra cost.

Aspirator Bottle GL 45 With Screw Cap and Stopcock

- Printed in white color

Cat. No.	Capacity, ml	Socket Size	Pack Size
12.155.1000	1000	14/23	1
12.155.2000	2000	19/26	1
12.155.3000	3000	24/29	1
12.155.5000	5000	29/32	1
12.155.9910	10000	29/32	1
12.155.9920	20000	29/32	1



Aspirator Bottle GL 45 With Screw Cap and Tubulation

Cat. No.	Capacity, ml	Pack Size
12.156.0250	250	1
12.156.0500	500	1
12.156.1000	1000	1
12.156.2000	2000	1
12.156.5000	5000	1



Washing Bottle - Flat Bottom Flask With Stopper And Inlet & Outlet Glass Tubes

- These bottles are mechanically strong and chemical resistant
- All sizes have a enameled area for marking
- Printed in white color

Cat. No.	Capacity, ml	Pack Size
12.164.0250	250	1
12.164.0500	500	1
12.164.1000	1000	1
12.164.2000	2000	1
12.164.5000	5000	1
12.164.9910	10000	1



Spare Head, For Flask Type Wash Bottles

Cat. No.	Capacity, ml	Pack Size
12.164.0005	250	2
12.164.0010	500	2
12.164.0015	1000	2



Bottles, Only For Flask Type Washing Bottles

Cat. No.	Capacity, ml	Pack Size
12.165.0125	250	2
12.165.0250	500	2
12.165.0500	1000	2



Gas Washing Bottle, Dreschel's

Inlet and outlet tubes in a stopper which fits the bottle having interchangeable 29/32 ground glass joint.

- These bottles are strong and chemical resistant
- All sizes have a enameled area for marking
- Printed in white color

Cat. No.	Capacity, ml	Pack Size
12.168.0125	125	1
12.168.0250	250	1
12.168.0500	500	1



Spare Head, For Dreschel's Gas Wash Bottles

Cat. No.	Capacity, ml	Pack Size
12.168.0005	125	2
12.168.0010	250	2
12.168.0015	500	2

Bottles, Only For Dreschel's Gas Washing Bottles

Cat. No.	Capacity, ml	Pack Size
12.169.0125	125	2
12.169.0250	250	2
12.169.0500	500	2

Weighing Bottle, Squat Form

Cat. No.	Dia., x Ht., mm (Approx)	Capacity, ml	Pack Size
12.136.4030	40 x 30	20	10
12.136.5025	50 x 25	15	10
12.136.5035	50 x 35	25	10
12.136.5050	50 x 50	50	10
12.136.6040	60 x 40	40	10



Weighing Bottle, Tall Form

- These bottles are strong and chemical resistant
- Made of borosilicate glass 3.3

Cat. No.	Dia., x ht., mm (Approx)	Capacity, ml	Pack Size
12.140.2040	20 x 40	5	10
12.140.2560	25 x 60	15	10
12.140.3060	30 x 60	25	10
12.140.4090	40 x 90	60	10



Amber Color Weighing Bottle, Squat Form

Cat. No.	Dia., x Ht., mm (Approx)	Capacity, ml	Pack Size
12.137.4030	40 x 30	20	10
12.137.5025	50 x 25	15	10
12.137.5035	50 x 35	25	10
12.137.5050	50 x 50	50	10
12.137.6040	60 x 40	40	10



Amber Color Weighing Bottle, Tall Form

Cat. No.	Dia., x ht., mm (Approx)	Capacity, ml	Pack Size
12.138.4020	20 x 40	5	10
12.138.6025	25 x 60	15	10
12.138.6030	30 x 60	25	10
12.138.9040	40 x 90	60	10



Specific Gravity Bottles, Weld With Cap

Cat. No.	Capacity, ml	Inner Joint	Outer Joint	Pack Size
12.141.0010	10	10/19	14/23	6
12.141.0025	25	10/19	14/23	6
12.141.0050	50	10/19	14/23	6



Pyknometer, Gay- Lussac (S.G. Bottle), Un Calibrated

- Labeling field for easy marking
- Manufactured from 3.3 Borosilicate Glass for corrosion-free performance

Cat No.	Capacity, ml	Pack Size
12.130.0005	5*	2
12.130.0010	10	2
12.130.0020	20	2
12.130.0025	25	2
12.130.0050	50	2
12.130.0100	100	2

* with glass stopper

Pyknometer, Gay- Lussac (S.G. Bottle), Calibrated, Class A

- In Compliance to ISO 3507
- Labeling field for easy marking
- Manufactured from 3.3 Borosilicate Glass for corrosion-free performance

Cat No.	Capacity ml.	Tolerance ± ml.	Pack Size
12.142.0005	5*	0.1	1
12.142.0010	10	0.3	1
12.142.0020	20	0.8	1
12.142.0025	25	0.8	1
12.142.0050	50	1.0	1
12.142.0100	100	2.0	1

* with glass stopper



Pyknometer, Gay- Lussac (S.G. Bottle), Calibrated, Class A, With NABL Works Certificate



Cat No.	Capacity ml.	Tolerance ± ml.	Pack Size
12.139.0005	5*	0.1	1
12.139.0010	10	0.3	1
12.139.0020	20	0.8	1
12.139.0025	25	0.8	1
12.139.0050	50	1.0	1
12.139.0100	100	2.0	1

* with glass stopper

Pyknometer With Ground-in Thermometer

- In Compliance to ISO 3507
- Labeling field for easy marking
- Manufactured from 3.3 Borosilicate Glass for corrosion-free performance
- Supplied with thermometer (0°C to 50°C)

Cat. No.	Capacity, ml	Pack Size
12.134.0010	10	1
12.134.0025	25	1
12.134.0050	50	1
12.134.0100	100	1

Pyknometer With Ground-in Thermometer, Class A With Individual Works Certificate

- In Compliance to ISO 3507
- Labeling field for easy marking
- Manufactured from 3.3 Borosilicate Glass for corrosion-free performance
- Supplied with thermometer (0°C to 50°C)
- With thermometer certificate

Cat. No.	Capacity, ml	Pack Size
12.145.0010	10	1
12.145.0025	25	1
12.145.0050	50	1
12.145.0100	100	1



Heating Mantle Multi Position



See Page No. 178

Distillation Apparatus

Moisture Determination Apparatus, Dean & Stark

Comprises of a boiling flask, reflux condenser and graduated receiver with glass stopcock

Cat. No.	Receiver Cap ml.	Flask Capacity, ml	Pack Size
16.410.0250	2	250	1
16.410.0500	5	500	1
16.410.1000	10	1000	1
16.410.1000-1	25	1000	1

Moisture Determination Apparatus, Dean & Stark, With NABL Certificate

Comprises of a boiling flask, reflux condenser and graduated receiver with glass stopcock. With NABL Certificate

Cat. No.	Receiver Cap ml.	Flask Capacity, ml	Pack Size
16.412.0250	2	250	1
16.412.0500	5	500	1
16.412.1000	10	1000	1
16.412.1000-1	25	1000	1

Essential Oil Determination Apparatus (Clevenger Type)

- Vertical tube joins with condenser and measuring tube with stopcock
- Return tube connects the bottom of the measuring tube and the vertical tube

Cat. No.	Flask Capacity, ml	Pack Size
16.426.1000	1000	1
16.426.2000	2000	1
16.426.3000	3000	1
16.426.5000	5000	1
16.426.9910	10000	1
16.426.9920	20000	1

Clevenger Apparatus

- This Apparatus is ideal for determination of volatile oil lighter than water
- Consists of 1000 ml. flask, 2ml Receiver with stopcock and condenser

Cat. No.	Pack Size
16.428.1000	1



Clevenger Apparatus

- This apparatus is ideal for determination of volatile oil heavier than water
- Consists of 1000 ml. flask, Receiver with stopcock and condenser

Cat. No.	Pack Size
16.430.1000	1



Distillation Apparatus

- Comprises of 2000 ml Flask, Friedrich Condenser and Stopper

Cat. No.	Pack Size
16.458.2000	1



Distillation Apparatus, Compact

- Comprises of 1000ml Erlenmeyer Flask and Friedrich Condenser

Cat. No.	Pack Size
16.460.1000	1

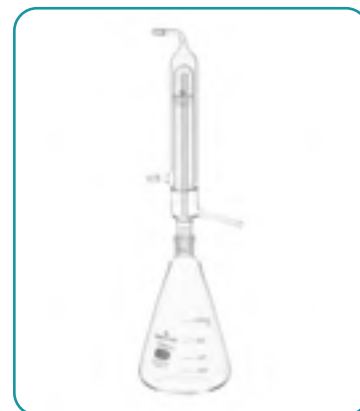

Reflux Assemblies

- Comprises of Round Bottom Flask and Air Condenser

Cat. No.	Flask Capacity ml.	Condenser effective length mm	Pack Size
16.464.0100	100	500	1
16.464.0250	250	750	1
16.464.0500	500	1000	1



Reflux Assemblies

- Comprises of Round Bottom Flask and Liebig Condenser

Cat. No.	Flask Capacity ml.	Condenser effective length mm.	Pack Size
16.468.0100	100	300	1
16.468.0250	250	400	1
16.468.0500	500	500	1

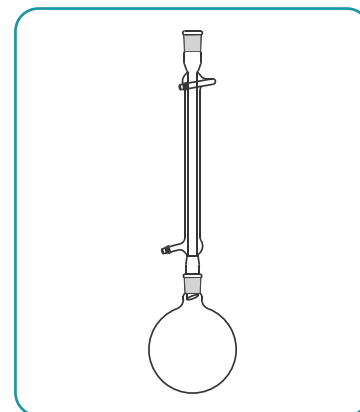

Reflux Assembly

- Comprises of Round Bottom Flask 1000 ml and a Reversible Coil Condenser

Cat. No.	Pack Size
16.470.1000	1



NITROGEN DETERMINATION ASSEMBLIES

Macro Kjeldahl Distillation

- 500 ml Kjeldahl Flask, multiple adapter, dropping funnel with plug
- Splash Head, condenser and receiver adapter

Cat. No.	Pack Size
16.432.0500	1

Macro Kjeldahl Distillation

- 500 ml Kjeldahl Flask, Multiple Adapter, Dropping Funnel with plug
- Splash Head, Condenser with spherical joints in between

Cat. No.	Pack Size
16.434.0500	1



Distilling Apparatus Ammonia

- Comprises of graham condenser used for determination of nitrogen in organic compounds

Cat. No.	Flask Capacity ml.	Pack Size
16.436.0500	500	1



Distillation Apparatus

- Comprises of 500 ml flask, graham condenser 200 mm and stopper

Cat. No.	Flask Capacity ml	Effective Condenser length mm.	Pack Size
16.438.0500	500	200	1

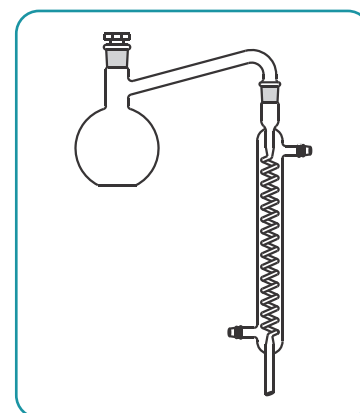

Alcohol Distillation Unit

- Comprises of R.B. 1000 ml, recovery bend, inland revenue condenser 200 mm and receiver adapter

Cat. No.	Flask ml.	Eff. Condenser length mm.	Pack Size
16.440.1000	1000	200	1

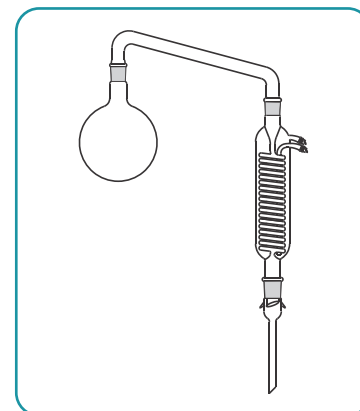

Distillation Apparatus

- Comprises of R. B., recovery bend, liebig condenser and receiver adapter

Cat. No.	Flask Capacity ml.	Effective Condenser length mm.	Pack Size
16.442.0250	250	200	1
16.442.0500	500	300	1
16.442.1000	1000	350	1
16.442.2000	2000	400	1



Preparation Assembly

- Comprises of R. B., still head, thermometer, liebig condenser and receiver adapter

Cat. No.	Flask Capacity ml.	Effective Condenser length mm.	Pack Size
16.444.0500	500	300	1
16.444.1000	1000	350	1
16.444.2000	2000	400	1

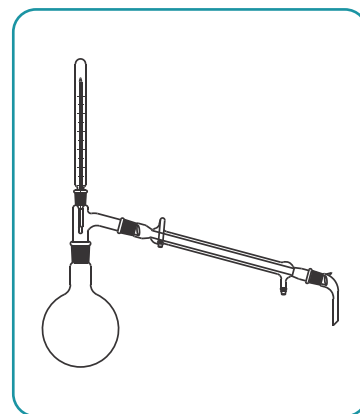

Vacuum Distillation

- Comprises of R. B. 1000 ml, recovery bend, jacketed coil condenser 150 mm, receiver adapter bent with vent and round bottom flask 250 ml.

Cat. No.	Flask Capacity ml.	Effective Condenser length mm.	Pack Size
16.446.1000	1000	150	1



Reichert Wollney's Apparatus

- For the Determination of Volatile Fatty Acids in Magarine and Butter, With Rubber Cork

Cat. No.	Pack Size
16.447.0050	1



Kjeldhal Distillation Assembly

- Comprises of kjeldhal flask 500 ml, multiple adapter two necks, splash head vertical, liebig condenser, receiver adapter and dropping funnel 100 ml.

Cat. No.	Flask Capacity ml.	Dropping Funnel Capacity ml.	Pack Size
16.450.0500	500	100	1



Arsenic Determination Apparatus as per IS

Cat. No.	Pack Size
16.459.0010	2

Arsenic Determination Apparatus as per IP Specs.

Cat. No.	Pack Size
16.462.0010	2

Arsenic Determination Apparatus, Gutzeit

Cat. No.	Pack Size
16.465.0010	2

Arsenic Determination Apparatus as per USP

Cat. No.	Pack Size
16.469.0010	2



Sulphur Di Oxide Assembly as per USP

Cat. No.	Pack Size
16.471.0010	1



R M Value Apparatus, IS 548 (Part-1)

• For dairy industries for determination of butter fat & analysis of oil/fat/waxes, with rubber cork fitting

Cat. No.	Capacity ml.	Pack Size
16.448.0300	300	1

Also available with standard joint fitting on request, please ask for prices.



Triple Water Bath



See Page No. 184

Tubes

supertek® brand Test tubes, Screw cap tubes is manufactured from Low-Expansion Boro 3.3 glass in conformance with ASTM E-438 TYPE 1 CLASS A glass & DIN ISO 3585. The test tubes are mechanically very strong, yet still retain good thermal shock resistance. These are printed in white enamel.

Test Tube - Borosilicate Glass

- Fire polished rim and uniform wall thickness
- In Compliance to ISO 4142
- Made of borosilicate 3.3 glass
- High thermal shock resistance & chemical attack resistance
- Available with & without rim
- Packed in breakage resistant special designed boxes.

With rim	Capacity ml (appx)	Size, mm	Pack Size
17.101.1075	3	75 x 10	100
17.101.1275	5	75 x 12	100
17.101.1210	7	100 x 12	100
17.101.1512*	13	125 x 15	100
17.101.1515*	15	150 x 15	100
17.101.1815	27	150 x 18	100
17.101.2510	38	100 x 25	100
17.101.2515	55	150 x 25	100
17.101.2520	70	200 x 25	100
17.101.3220	100	200 x 32	100
17.101.3820	170	200 x 38	50



Without rim	Capacity ml (appx)	Size, mm	Pack Size
17.104.1075	3	75 x 10	100
17.104.1275	5	75 x 12	100
17.104.1210	7	100 x 12	100
17.104.1512*	13	125 x 15	100
17.104.1515*	15	150 x 15	100
17.104.1815	27	150 x 18	100
17.104.2510	38	100 x 25	100
17.104.2515	55	150 x 25	100
17.104.2520	70	200 x 25	100
17.104.3220	100	200 x 32	100
17.104.3820	170	200 x 38	50

Test Tubes, Graduated

- Fire polished rim and uniform wall thickness
- Made of borosilicate 3.3 glass
- High thermal shock resistance & chemical attack resistance
- Round Bottom, With rim
- Graduated in Amber

Cat. No.	Capacity ml (appx)	Size,mm	Pack Size
17.106.1075	3	75 x 10	10
17.106.1275	5	75 x 12	10
17.106.1210	7	100 x 12	10
17.106.1512	13	125 x 15	10
17.106.1815	27	150 x 18	10
17.106.2515	55	150 x 25	10
17.106.2520	70	200 x 25	10



Tube Flat Bottom With Rim

- Made of borosilicate glass, designed with a flat bottom
- High thermal shock resistance
- Used for pathological tests and disintegration apparatus

Cat. No.	Approx. O.D. x Length mm	Pack Size
17.110.1813	18 x 138	100
17.110.1855	18 x 55	100
17.110.1411	14 x 110	100



Tube Flat Bottom Without Rim

- Made of borosilicate glass, designed with a flat bottom
- High thermal shock resistance
- Used for pathological tests and disintegration apparatus

Cat. No.	Approx. O.D. x Length mm	Pack Size
17.109.1275	12 x 75	100



Culture Tubes, Flat Bottom Clear

- Made from Boro Glass 3.3, Clear
- Printed in Matt finish white colour enamel
- Uniform Wall Thickness
- Leakproof
- Comes with PP Screw Cap and PTFE Liner

Cat No.	Capacity ml	Size, mm	Pack Size
17.122.1638*	3	16 x 38	100
17.122.1655*	5	16 x 55	100
17.122.2550	10	25 x 50	100
17.122.2557	15	25 x 57	100
17.122.2572	20	25 x 72	100
17.122.2595	30	25 x 95	100
17.122.2515	50	25 x 150	100

3ml & 5ml with stopper



Culture Tubes, Flat Bottom Amber

- Made from Boro Glass 5.1, Amber
- Printed in Matt finish white colour enamel
- Uniform Wall Thickness
- Leakproof
- Comes with PP Screw Cap and PTFE Liner

Cat No.	Capacity ml	Size, mm	Pack Size
17.139.1638*	3	16 x 38	100
17.139.1655*	5	16 x 55	100
17.139.2550	10	25 x 50	100
17.139.2557	15	25 x 57	100
17.139.2572	20	25 x 72	100
17.139.2595	30	25 x 95	100
17.139.2515	50	25 x 150	100

3ml & 5ml with stopper



Culture Tubes, Round Bottom, Clear

- Made from Boro Glass 3.3, Clear
- Printed in Matt finish white colour enamel
- Uniform Wall Thickness
- Leakproof
- Comes with PP Screw Cap and PTFE Liner

Cat No.	Capacity ml	Size, mm	Pack Size
17.123.1210	5	12 x 100	100
17.123.1675	5	16 x 75	100
17.123.1610	10	16 x 100	100
17.123.1612	15	16 x 125	100
17.123.1615	20	16 x 150	100
17.123.1815	25	18 x 150	100
17.123.1818	30	18 x 180	100
17.123.2510	25	25 x 100	100
17.123.2515	50	25 x 150	100
17.123.2520	60	25 x 200	50
17.123.3220	100	32 x 200	25
17.123.3820	150	38 x 200	25



Culture Tubes, Round Bottom, Amber

- Made from Boro Glass 5.1, Amber
- Printed in Matt finish white colour enamel
- Uniform Wall Thickness
- Leakproof
- Comes with PP Screw Cap and PTFE Liner

Cat No.	Capacity ml	Size, mm	Pack Size
17.138.1210	5	12 x 100	100
17.138.1675	5	16 x 75	100
17.138.1610	10	16 x 100	100
17.138.1615	20	16 x 150	100
17.138.1815	25	18 x 150	100
17.138.1818	30	18 x 180	100
17.138.2515	50	25 x 150	100
17.138.2520	60	25 x 200	50
17.138.3220	100	32 x 200	25
17.138.3820	150	38 x 200	25



Test Tube - With Joint & Stopper, Plain

Cat. No.	Length x Dia., mm	Socket Size	Capacity ml	Pack Size
17.120.1210	100 x 12	10/19	5	10
17.120.1512	125 x 15	12/21	10	10
17.120.1815	150 x 18	14/23	20	10
17.120.2515	150 x 25	19/26	25	10
17.120.2520	200 x 25	19/26	50	10
17.120.3220	200 x 32	24/29	100	10
17.120.3820	200 x 38	24/29	150	10



Test Tube - With Joint & Stopper, Graduated

Cat. No.	Size, mm	Capacity ml	Socket Size	Pack Size
17.124.0005	100 x 12	5	10/19	10
17.124.0010	125 x 16	10	12/21	10
17.124.0012	150 x 16	15	12/21	10
17.124.0013	150 x 18	20	14/23	10
17.124.0015	150 x 22	25	19/26	10
17.124.0020	200 x 25	50	19/26	10
17.124.0035	230 x 32	100	24/29	10



Centrifuge Tube, Conical Bottom, Plain

• Centrifuge tubes are thick-walled and resistant to mechanical stress

Cat. No.	Capacity, ml	Height x O.D., mm	Pack Size
17.146.0005	3	76 x 10	100
17.146.0010	5	100 x 13	100
17.146.0015	10	110 x 15	100
17.146.0020	12	110 x 16	100
17.146.0025	15	120 x 17	100
17.146.0030	25	125 x 22	50
17.146.0037	50	135 x 30	50



Centrifuge Tube, Conical Bottom, Graduated

• Centrifuge tubes are thick walled, resistant to mechanical stress

Cat. No.	Capacity, ml	Height x O.D., mm	Pack Size
17.150.0005	5	100 x 13	30
17.150.0010	10	110 x 15	30
17.150.0015	15	120 x 17	30
17.150.0020	25	125 x 22	20
17.150.0027	50	135 x 30	20



Centrifuge Tube, With Screw Cap, Plain

Cat. No.	Capacity, ml	Height x O.D., mm	Pack Size
17.154.0010	10	110 x 15	100
17.154.0015	15	120 x 17	100
17.154.0020	50	135 x 30	100



Centrifuge Tube, With Screw Cap, Graduated

Cat. No.	Capacity, ml	Height x O.D., mm	Pack Size
17.158.0010	10	110 x 15	100
17.158.0015	15	120 x 17	100
17.158.0020	50	135 x 30	100



Centrifuge Tube, Conical Bottom Graduated, With Interchangeable Stopper

Cat. No.	Capacity, ml	Height x O.D., mm	Pack Size
17.166.0010	5	100 x 13	100
17.166.0015	12	110 x 16	100
17.166.0020	15	120 x 17	100
17.166.0025	25	125 x 22	50
17.166.0030	50	140 x 29	50



Blood Sugar Tubes, Folin Wu, as per I.S. 3740 : 1966, Capacity 25 ml., marked at 4 ml, 12.5 ml and 25 ml

Cat. No.	Capacity, ml	Pack Size
17.172.0025	25	20

Marked at 12.5 & 25ml

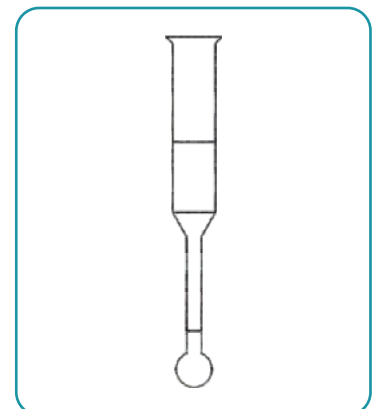

Tubes, Digestion, Folin-Wu, marked at 35 ml and 50 ml

Cat. No.	Size,mm	Pack Size
17.174.2520	200 x 25	20



Impinger, Graduated For Sampling Small Gas Volume As per Standard Specification

Cat. No.	Capacity, ml	Pack Size
17.175.0035	35	10
17.175.0050	50	10
17.175.0080	80	10
17.175.0150	150	5
17.175.0225	225	5
17.175.0240	240	5
17.175.0275	275	5

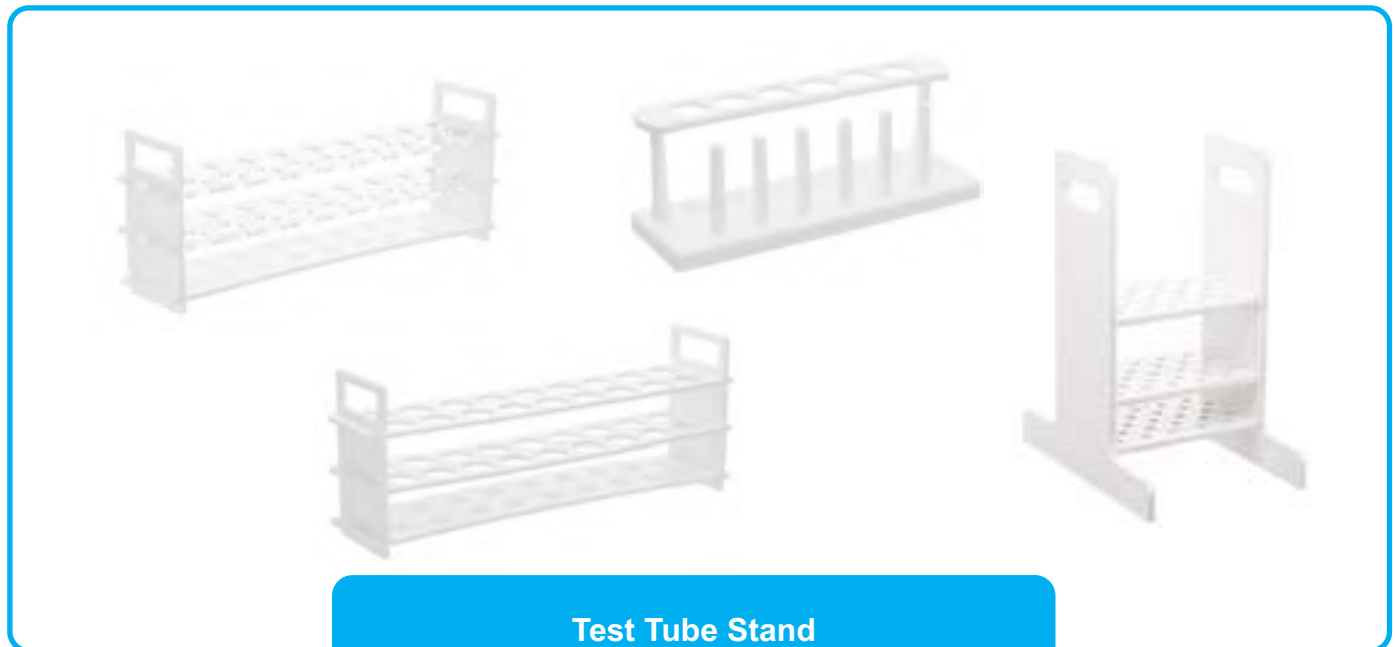

**Test Tube Stand
See Page No. 199**

Quartzware

Beaker Low Form with Spout

Cat No.	Capacity ml	Pack Size
CHQT1/1	25	2
CHQT1/2	50	2
CHQT1/3	100	2
CHQT1/4	250	1
CHQT1/5	500	1
CHQT1/6	1000	1

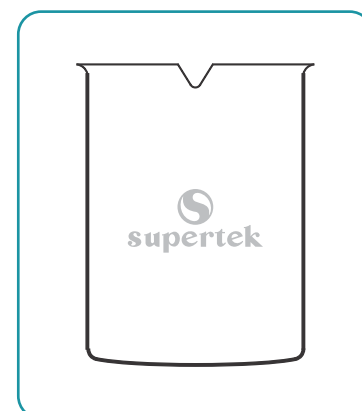

Conical Flask

Cat No.	Capacity ml	Pack Size
CHQT4/1	25	2
CHQT4/2	50	2
CHQT4/3	100	1
CHQT4/4	250	1
CHQT4/5	500	1
CHQT4/6	1000	1

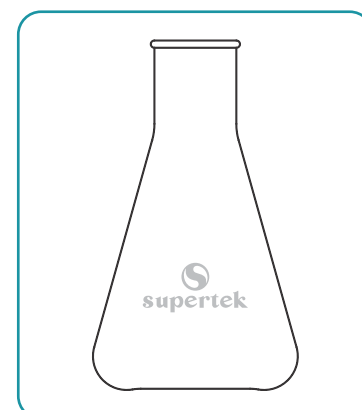

Volumetric Flask With Stopper

Cat No.	Capacity ml	Socket	Pack Size
CHQT5/1	10	10/19	1
CHQT5/2	25	10/19	1
CHQT5/3	50	12/21	1
CHQT5/4	100	14/23	1
CHQT5/5	250	14/23	1
CHQT5/6	500	19/26	1



Reagent Bottle With Stopper

Cat No.	Capacity ml	Socket	Pack Size
CHQT6/1	50	14/23	1
CHQT6/2	100	14/23	1
CHQT6/3	250	19/26	1
CHQT6/4	500	24/29	1
CHQT6/5	1000	29/32	1



Test Tube With Rim

Cat No.	Capacity ml (Approx.)	O.D. X Length mm (Approx.)	Pack Size
CHQT9/1	3	10 x 75	5
CHQT9/2	5	12 x 75	5
CHQT9/3	8	12 x 100	5
CHQT9/4	10	16 x 125	5
CHQT9/5	15	16 x 150	5
CHQT9/6	25	18 x 150	2
CHQT9/7	35	25 x 100	2
CHQT9/8	50	25 x 150	2
CHQT9/9	75	25 x 200	2
CHQT9/10	100	32 x 200	2
CHQT9/11	175	40 x 200	2

Combustion Boat With Handle

Cat No.	O.D. X Length mm (Approx.)	Pack Size
CHQT10/1	16 x 49	2
CHQT10/2	12 x 77	2
CHQT10/3	18 x 77	2
CHQT10/4	22 x 77	2
CHQT10/5	22 x 100	2

Crucible Without Lid

Cat No.	Capacity ml (Approx.)	O.D. X Height mm (Approx.)	Pack Size
CHQT11/1	15	40 x 26	5
CHQT11/2	25	47 x 30	5
CHQT11/3	50	57 x 35	5
CHQT11/4	80	69 x 45	5
CHQT11/5	150	80 x 54	5

Lid For Crucible

Cat No.	Capacity ml (Approx.)	Pack Size
CHQT12/1	15	5
CHQT12/2	25	5
CHQT12/3	50	5
CHQT12/4	80	5
CHQT12/5	150	5



Porcelain & Silicaware

Mortar & Pestle, Porcelain

- Mortar with spout, glazed outside except bottom, unglazed inside. Pestle unglazed to grinding surface

Cat No.	Inside Dia., mm	Capacity, ml	Pack Size
CH11605/1	60	60	1
CH11605/2	75	100	1
CH11605/3	85	150	1
CH11605/4	100	275	1
CH11605/5	125	550	1
CH11605/6	150	900	1
CH11605/7	175	1500	1
CH11605/8	200	2000	1



Mortar & Pestle, Agate

- Made of Naturally occurring Agate Stone, recommended for use in laboratories demanding contamination-free results

Cat No.	O.D., mm	I.D., mm	Ht., mm	Pack Size
CH11610/2	28	23	20	1
CH11610/3	40	31	27	1
CH11610/4	50	40	30	1
CH11610/5	60	57	33	1
CH11610/6	78	65	39	1
CH11610/7	100	87	44	1
CH11610/8	115	100	51	1
CH11610/9	125	111	61	1
CH11610/10	150	134	63	1



Mortar & Pestle, Agate, Black

Cat No.	O.D. mm	I.D. mm	Height, mm	Pack Size
CH11611/1	50	40	30	1
CH11611/2	60	57	33	1
CH11611/3	75	65	39	1
CH11611/4	100	87	44	1
CH11611/5	115	100	51	1
CH11611/6	125	111	61	1
CH11611/7	150	134	63	1



Basins, Evaporating

- Porcelain, round form, with lip, both sides glazed. For bigger dishes, glazed inside and partially outside

Cat No.	Dia., mm	Capacity, ml	Pack Size
CH10110/3	50	20	1
CH10110/5	75	100	1
CH10110/7	100	175	1
CH10110/9	125	450	1
CH10110/11	150	850	1
CH10110/13	200	1700	1



Combustion Boat, Porcelain

- Glazed /unglazed max
- use temp. 1150° C

Cat No.	Length, mm	Pack Size
CH10742/1	90	10
CH10742/3	80	10
CH10742/5	86	10
CH10742/7	100	10



Funnel, Buchner

- Porcelain, straight sides, integral perforated plate, glazed inside and outside

Cat No.	Dia., mm	Pack Size
CH11108/1	35	1
CH11108/2	50	1
CH11108/4	60	1
CH11108/5	75	1
CH11108/6	100	1
CH11108/7	125	1
CH11108/8	150	1
CH11108/9	200	1
CH11108/9A	250	1
CH11108/10	300	1



Crucible With Lid, Silica

Cat. No.	Capacity ml	Pack Size
CHSIL1/1	15	1
CHSIL1/2	25	1
CHSIL1/3	50	1
CHSIL1/4	100	1
CHSIL1/5	80	1
CHSIL1/6	150	1



Crucible Without Lid, Silica

Cat. No.	Capacity ml	Pack Size
CHSIL2/1	15	1
CHSIL2/2	25	1
CHSIL2/3	50	1
CHSIL2/4	100	1
CHSIL2/5	80	1
CHSIL2/6	150	1



Basin Round Bottom, With Spout, Translucent, Silica

Cat. No.	Capacity ml.	Dia x Ht. Approx.	Pack Size
CHSIL3/1	20	55 x 23	1
CHSIL3/2	45	75 x 27	1
CHSIL3/3	70	87 x 33	1
CHSIL3/4	85	94 x 36	1
CHSIL3/5	100	100 x 45	1
CHSIL3/6	200	113 x 47	1

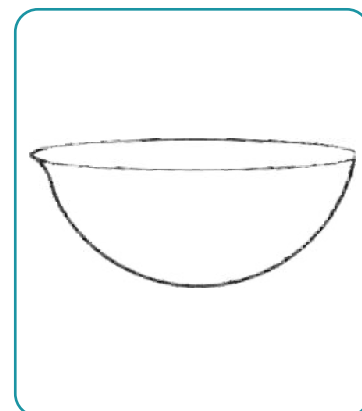

Silica Triangle on Nichrome

Cat. No.	Capacity ml.	Pack Size
CHSIL4/1	15	1
CHSIL4/2	25	1
CHSIL4/3	50	1
CHSIL4/4	80	1
CHSIL4/5	100	1

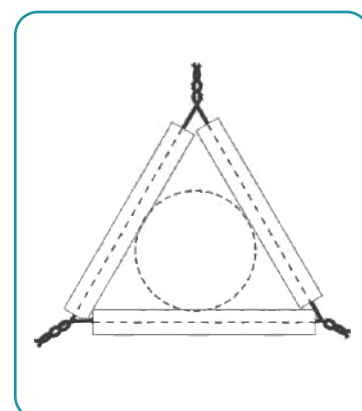

Distillation Stills

Water Still

- Easy to use, safe to operate and designed for trouble free continues operation. Suitable for general laboratory use.

Features :

- Water still features high quality borosilicate glass boiler and condenser with PTFE stopcock for easy cleaning
- All plumbing connections through thread connectors
- Chrome plated heating element fitted with a thermostat
- Features a powder coated metal stand for either wall or bench mounting

Technical Specifications

- Distilled Water Output: 4 L/Hr
- Power Rating: 3 kW
- Input voltage: 220 V AC \pm 10%, 50-60 Hz

Cat No.	Pack Size
CH14030	1



Mono Quartz Distillation Units

- Mono quartz distillers being very compact and the construction material being high purity quartz, it meets the standard of the analytical laboratory where purity of distilled water free from metallic ions and bacteria is criteria.

Construction

- The boiler is made of high purity quartz and the condenser is of borosilicate/quartz material. The built in heater provides minimum loss of heat and production of distilled water in 2-3 minutes. The unit is mounted on a powder coated metal stand with electrical connections and is easy to dismantle and assemble the unit. Fibre glass insulated wire and silicone rubber boot resists high temperatures

Features :

- Quartz boiler
- Condenser is available in borosilicate and quartz material.
- Distilled water output in 2-3 minutes.
- Pyrogen free, free of heavy metals.
- Efficient borosilicate/quartz coil condenser.
- Can be easily converted to bi-distillation apparatus.
- Powder coated stand for rust free operation.
- Safety cut off device is optional

Distillate Quality

- Conductivity:
 - < 3.0 μ S/cm with Borosilicate Condenser
 - < 2.0 μ S/cm with Quartz Condenser
- Distillate Temperature: 30 to 45 °C
- Distilled Water Quality: Pyrogen Free

Cat No.	Condenser Material	Distilled Water Output, L/Hr	Cooling Water Consumption, L/Hr	Power Rating, kW
CH14042-25B	Borosilicate	2.5	40	2.0
CH14042-25Q	Quartz	2.5	40	2.0
CH14042-50B	Borosilicate	5.0	65	4.4
CH14042-50Q	Quartz	5.0	65	4.4
CH14042-100B	Borosilicate	10.0	120	9.0*
CH14042-100Q	Quartz	10.0	120	9.0*

* Indicates 3 Phase connection

SAFETY CUT OFF DEVICE IS OPTIONAL

Safety cut off Device

Cat. No.	Capacity	Description
CH14042-SCU-1	2 ltr/hr	Digital Safety Control Unit with Alarm
CH14042-SCU-2	5 & 10 ltr/hr	Digital Safety Control Unit with Alarm



Double Quartz Distillation Units

- Quartz distillation units are manufactured from imported fused quartz tubes. The exceptionally high chemical purity and very low solubility of this material enables the production of very high-performance system. The greatest possible attention has been taken for technical performance, simplicity of use and efficiency.

Construction

- The unit consist of a primary boiler with built-in heater enclosed in a quartz boiler. Upper boiler has a built-in quartz coil and condensing unit which is mounted on the boiler. Double wall condenser ensures separate condensation of vapor coming from the two boilers using a single cooling circuit.

Features :

- Quartz boiler
- Quartz condenser
- Distilled water output in 2-3 minutes.
- Pyrogen free, free of heavy metals.
- Powder coated stand for rust free operation.
- Safety cut off device is included.

Distillate Quality

- Conductivity: <math>< 1.0 \mu\text{S/cm}</math>
- Distillate Temperature: 65 to 75°C
- Distilled Water Quality: Pyrogen Free

Cat No.	Distilled Water Output, L/Hr	Cooling Water Consumption, L/Hr	Total Power Rating, kW
CH14045-15DQ	1.5	60	3.0
CH14045-25DQ	2.5	70	4.4
CH14045-35DQ	3.5	90	7.0*
CH14045-40DQ	4.0	120	8.0*
CH14045-50DQ	5.0	150	9.0*

* Indicates 3 Phase connection



Borosilicate Distillation Units

- Borosilicate glass distillation units continue to be the most effective, economic method of producing ultra-pure water for laboratory use. By contrast deioniser are only effective in removing those substances which are ionized. Further the resins contribute organic impurities to water and an ideal environment for bacterial growth in course of time.
- These distillation units are designed to produce a distillate of consistent purity. The unit consists of horizontal borosilicate boilers, condensers, and quartz heater. All parts are replaceable.
- The newly developed quartz heater is advantageous than chromium plated heaters. Chromium plated heaters react with acids during cleaning process. Quartz heaters do not react with acids or water during cleaning or at elevated temperature unlike metallic ones. Quartz heaters are easy to assemble and dismantle, unlike metallic ones which are bulky.

Features :

- Compact, simple to use.
- Economical and ideal for colleges and general laboratory use.
- Borosilicate boiler, borosilicate condenser and quartz heater
- Powder coated stand for rust free operation.
- Provision for easy cleaning of boiler
- Input voltage: 220 V AC \pm 10%, 50-60 Hz

Distillate Quality

- Conductivity: <math>< 3.0 \mu\text{S/cm}</math>
- Distilled Water Quality: Pyrogen Free

Cat No.	Distilled Water Output, L/Hr	Stage	Cooling Water Consumption, L/Hr	Total Power Rating, kW
CH14031-20S	2.0	Single Stage	50	1.5
CH14031-40S	4.0	Single Stage	60	3.0
CH14031-20D	2.0	Double Stage	120	3.0
CH14031-40D	4.0	Double Stage	150	6.0



Automatic Water Distillation (Cabinet Model)

Features :

- Compact and user friendly.
- For use in research laboratories, hospitals etc.
- Borosilicate boiler, borosilicate condenser and quartz heater
- Safety features:
 - Equipment will shut off in case of cooling water failure.
 - Equipment will shut off in case water level in the boiler falls below the heater.
- Replaceable quartz heater.
- Replaceable side overflow for easy draining and cleaning of boiling chamber.
- Input voltage: 220 V AC \pm 10%, 50-60 Hz

Distillate Quality

- Conductivity: < 3.0 μ S/cm
- Distilled Water Quality: Pyrogen Free

Cat No.	Distilled Water Output, L/Hr	Stage	Cooling Water Consumption, L/Hr	Total Power Rating, kW
CH14032/1	2	Single Stage	1.5	1.5
CH14032/2	4	Single Stage	2.5	3.0
CH14032/3	2	Double Stage	1.5	1.5
CH14032/4	4	Double Stage	2.5	3.0



Equipment
See Page No. 174-187

Essentials



Tools that elevate your Scientific Expertise

Filter Papers - Qualitative

General Properties of **supertek**® Filter Papers

Grade	Particle Retention	Initial Filtration Speed	Thickness, mm	Weight, g/m2	Dry Bursting Strength, kPa
Qualitative	Liquid, µm	(Secs/100 ml)			
1	9	155	0.20	87	89
2	9	250	0.21	98	108
3	5	325	0.40	180	187
4	22	38	0.21	95	67
5	2.5-3	1480	0.21	95	173



Filter Paper Grade 1

Qualitative, Pack of 100

Cat No.	Diameter, mm
FP-001-090	90
FP-001-110	110
FP-001-125	125
FP-001-150	150
FP-001-185	185
FP-001-215	215
FP-001-240	240

Filter Paper Grade 2

Qualitative, Pack of 100

Cat No.	Diameter, mm
FP-002-090	90
FP-002-110	110
FP-002-125	125
FP-002-150	150
FP-002-185	185
FP-002-215	215
FP-002-240	240

Filter Paper Grade 3

Qualitative, Pack of 100

Cat No.	Diameter, mm
FP-003-090	90
FP-003-110	110
FP-003-125	125
FP-003-150	150
FP-003-185	185
FP-003-215	215
FP-003-240	240

Filter Paper Grade 4

Qualitative, Pack of 100

Cat No.	Diameter, mm
FP-004-090	90
FP-004-110	110
FP-004-125	125
FP-004-150	150
FP-004-185	185
FP-004-215	215
FP-004-240	240

Filter Paper Grade 5

Qualitative, Pack of 100

Cat No.	Diameter, mm
FP-005-090	90
FP-005-110	110
FP-005-125	125
FP-005-150	150
FP-005-185	185
FP-005-215	215
FP-005-240	240

Filter Paper Sheet (46x57cm)

Cat No.	Grade
FPS-01-100	1
FPS-01-500	1
FPS-02-100	2
FPS-02-500	2
FPS-03-100	3
FPS-03-500	3
FPS-04-100	4
FPS-04-500	4
FPS-05-100	5
FPS-05-500	5

Filter Papers - Quantitative

General Properties of **supertek**® Filter Papers (Ashless)

Grade	Particle Retention	Product Appearance	Filtration Speed	Ash Content (%)	Basis Weight (g/m ²)	Thickness (mm)
Qualitative	Liquid, μm					
40	8	Smooth	Medium	< 0.007	90-95	0.21
41	20-25	Smooth	Fast	< 0.007	80-90	0.19-0.25
42	2.5	Smooth	Slow	< 0.007	90-100	0.18-0.20

Filter Paper Grade S40

- Quantitative, Pack of 100

Cat No.	Diameter, mm
FP-040-090	90
FP-040-110	110
FP-040-125	125
FP-040-150	150



Filter Paper Grade S41

- Quantitative, Pack of 100

Cat No.	Diameter, mm
FP-041-090	90
FP-041-110	110
FP-041-125	125
FP-041-150	150



Filter Paper Grade S42

- Quantitative, Pack of 100

Cat No.	Diameter, mm
FP-042-090	90
FP-042-110	110
FP-042-125	125
FP-042-150	150



Laboratory Jacks

Laboratory Jacks

Laboratory jacks are designed to lift and hold heavy chemistry and physics apparatuses. Ideal for supporting glassware, hotplates and other small instruments that require precise height regulation. Scissor type lab jacks comes in different sizes and materials

Features :

- Platform material: Available in aluminium, mild steel and stainless steel
- Smooth and precise lift movement
- Ergonomic knob design
- A ratchet to lift heavy load is included in all models
- Includes support rod
- Non-slip rubber feet

Cat No.	Platform Material	Size	Max. Height	Dynamic Load (kg)	Static Load (kg)	Pack Size
CH12385A/1	Aluminium	4.5" x 6"	10" (25cm)	5	30	1
CH12385A/2	Aluminium	6" x 6"	10" (25cm)	7	30	1
CH12385A/3	Aluminium	8" x 8"	11" (28cm)	7	30	1
CH12385A/4	Aluminium	10" x 10"	16.5"(42cm)	15	60	1
CH12385A/5	Aluminium	12" x 12"	20.5"(52cm)	15	60	1
CH12385B/1	Mild Steel	4.5" x 6"	10" (25cm)	5	30	1
CH12385B/2	Mild Steel	6" x 6"	10" (25cm)	7	30	1
CH12385B/3	Mild Steel	8" x 8"	11" (28cm)	7	30	1
CH12385B/4	Mild Steel	10" x 10"	16.5"(42cm)	15	60	1
CH12385B/5	Mild Steel	12" x 12"	20.5"(52cm)	15	60	1
CH12385C/1	SS	4.5" x 6"	10" (25cm)	5	30	1
CH12385C/2	SS	6" x 6"	10" (25cm)	7	30	1
CH12385C/3	SS	8" x 8"	11" (28cm)	7	30	1
CH12385C/4	SS	10" x 10"	16.5"(42cm)	15	60	1
CH12385C/5	SS	12" x 12"	20.5"(52cm)	15	60	1



Laboratory Jacks, Superior

Laboratory jacks are designed to lift and hold heavy chemistry and physics apparatuses. Ideal for supporting glassware, hotplates and other small instruments that require precise height regulation. All the parts in superior laboratory jacks are made of stainless steel material.

Features :

- Platform as well as the scissor assembly is made of stainless steel material
- Smooth and precise lift movement
- Ergonomic knob design
- Corrosion resistant
- A ratchet to lift heavy load is included in all models
- Includes support rod
- Non-slip rubber feet

Cat No.	Size	Max. Height	Dynamic Load (kg)	Static Load (kg)	Pack Size
CH12386C/1	4.5" x 6"	10" (25cm)	5	30	1
CH12386C/2	6" x 6"	10" (25cm)	7	30	1
CH12386C/3	8" x 8"	11" (28cm)	7	30	1
CH12386C/4	10" x 10"	16.5"(42cm)	15	60	1
CH12386C/5	12" x 12"	20.5"(52cm)	15	60	1



Accessories

Burette Clamp

- Holds burette in vertical position, die pressed burette clamp of plated steel, jaws having V grooves. With boss to accommodate rods upto 16 mm dia.

Cat No.		Pack Size
CH10540/1	For One Burette	1
CH10540/2	For Two Burettes	1

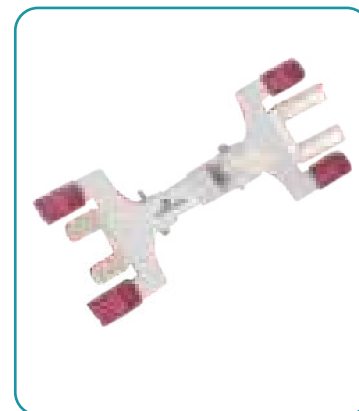

Burette Clamp, Sheet Metal

- For holding burettes vertically in a retort stand, sheet metal, die pressed with built-in boss head and spring loaded jaws covered with rubber sleeve.

Cat No.		Pack Size
CH10543/1	For One Burette	1
CH10543/2	For Two Burettes	1



Burette Clamp, Metal, Die Cast

- Complete body of die cast metal making it light weight, durable and sturdy. Provided with a spring loaded positive grip and release. The special design provides vice like grip to the burette for a positive clamping. Boss head clamp secures a firmly at desired position on the rod of about 13 mm diameter.

Cat No.		Pack Size
CH10546/1	For One Burette	1
CH10546/2	For Two Burettes	1

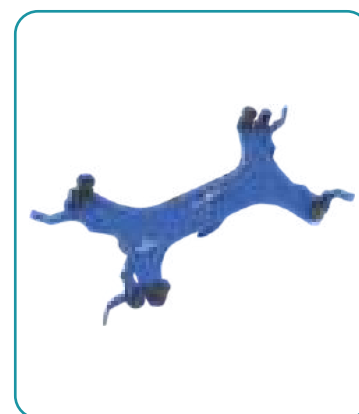

Burette Clamp

Rounded steel jaws, for use with retort stands. Jaws opening from 10 to 35 mm diameter. Jaws can be rotated through 360° and locked in any position. fits support rods upto 15 mm diameter.

Cat No.		Pack Size
CH12349/1		1
CH12349/3	with plastic coated jaws	1



Clamp

- Pressed metal, cork lined jaws, can open upto 50 mm, black painted.

Cat No.	Pack Size
CH12325/1	2



Universal Clamp

- Pressure die cast aluminium alloy, other parts are of plated brass, cork lined, ensures firm grip at all angles of opening, opens upto 90mm, with 250x8mm nickel plated mild steel rod.

Cat No.	Pack Size
CH12340	2



Clamp, 3 Prong

- Die cast aluminium, with plated brass inserts, accepts articles upto 70mm diam, rubber covered jaws.

Cat No.	Pack Size
CH12345	1



Extension Burette Clamp, Economy Choice

- Extension clamp with round, cork- coated jaws. Will hold burettes, test tubes and flasks upto 2 1/2" in diameter. Overall length is 8"

Cat No.	Pack Size
CH12348	2



Clamp, Extension Universal

- A steel clamp with a locking swivel. The swivel permits orientation at a wide variety of angles. Outer jaws open freely to accommodate apparatus like condenser and other irregular shapes. Jaws are covered with a plastic material to cushion apparatus held in the jaws.

Cat No.	Pack Size
CH12352/1 Jaw Opening Size 2"	1
CH12352/3 Jaw Opening Size 3"	1



Rings With Clamps

- Cast iron with side arm & V clamp to fit rods upto 13 mm. The distance from support clamp centre to centre of ring is 4½" for all rings. Fits ¼" rods

Cat No.	ID, Inch	Pack Size
CH12371/1	2	2
CH12371/2	3	2
CH12371/3	3½	2
CH12371/4	4½	2
CH12371/5	5½	2



Retort Stand Ring

- Iron, with integral boss to accept rods upto 12 mm diam. Boss is fitted with a plated thumb screw.

Cat No.	Dia., mm	Pack Size
CH12374/2	50	2
CH12374/4	75	2
CH12374/6	100	2
CH12374/7	125	2
CH12374/8	150	2



Boss Head

- Zinc Alloy, with nickel plated clamping screws, can accommodate rods up to 12 mm.

Cat No.	Pack Size
CH12357	2



Boss Head

- Pressure die cast aluminium alloy. With offset jaws, nickel plated clamping screws, to hold rods up to 16 mm. with stands heavy clamping pressure.

Cat. No.	Pack Size
CH12359	2



Clamp Holder (Boss Head)

- Aluminum alloy with plastic clamping screws, holds rods up to 5/8" in diameter. With offset jaws for greater strength.

Cat. No.	Pack Size
CH12360	2



Tripod Stand

- Triangular top of cast iron, with steel legs bent outwards for stability, painted.

Cat No.	Length of one side, mm	Ht., mm	Pack Size
CH13055/2	100	150	1
CH13055/4	125	200	1



Tripod Stand, Steel

- Triangular top, all steel welded, legs bent outward for stability. Length of one side 130 mm, height 200 mm.

Cat No.	Pack Size
CH13058	1



Tripod Stand, Circular

- Cast iron top, steel legs bent outward.

Cat No.	Diam., mm	Ht., mm	Pack Size
CH13060/1	100	150	1
CH13060/3	125	200	1



Tripod Stand, Circular

- Consists of a circular top attached to steel legs. The lower half of the legs are bent for maximum stability.

Cat. No.	Size	Pack Size
CH13062/1	210 mm	1
CH13062/3	190 mm, with triangular	1

* attachment at base



Plasticware
See Page No. 188-202

Crucible Tongs

- Jaws corrugated inside

Cat No.	With Bow Type	Length, mm	Pack Size
CH13005/1	Iron, plated	150	6
CH13005/2	Iron, plated	200	6
CH13005/8	Stainless Steel	150	6
CH13005/9	Stainless Steel	200	6



Crucible Tongs

- General purpose Stainless Steel tongs, for handling hot apparatus. Tips are serrated. Length approximately 9"

Cat No.	Pack Size
CH13010/3	1



Beaker Tongs

- Stainless steel, jaws covered with asbestos, can firmly hold any beaker from 250 ml to 1000 ml.

Cat No.	Length, mm	Pack Size
CH13025/3	300	1



Beaker Tongs

- Made of nickel plated steel, with plastic-coated jaws that open to 4 1/2".
- Holds 50 to 2000ml beakers. Length 9 1/2".

Cat No.	Pack Size
CH13030	1



Beaker Tongs, Heavy Duty

- For hot beakers from 100 to 1500 ml capacity. Stainless steel with riveted joint and fiberglass-covered jaws. Length: 12 1/2"

Cat No.	Pack Size
CH13035	1



Flask Tongs

- Stainless steel, cork lined, rectangular jaws

Cat No.	Length, mm	Pack Size
CH13038/2	250	1
CH13038/4	300	1



Muffle Furnace Crucible Tongs

- Stainless steel, Long and rigid for furnace use
- With large handles and serrated tips
- Total length : 18"

Cat No.	Pack Size
CH13040	1

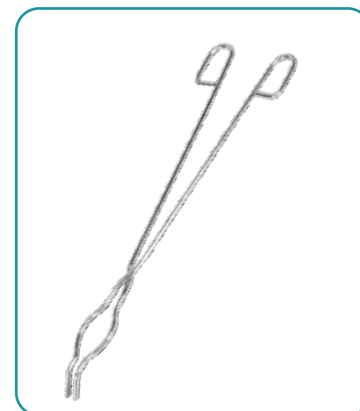

Retort Stand

- Heavy black enamel cast iron base with plated rods, which are threaded to fit the base.

Cat No.		Pack Size
CH12321/1	Base 4" x 6-3/4" with 5/16" x 18" Rod	1
CH12321/2	Base 5" x 8" with 3/8" x 20" Rod	1
CH12321/3	Base 5-1/2"x9"with 1/2"x24"Rod	1
CH12321/4	Base 6-1/2" x 11" with 1/2" x 36" Rod	1



Retort Stand

- Steel base with tapped hole, (10 x 1.5 mm metric thread) in the center of one short side. Finished in blue and fitted with rubber feet.

Cat No.	Size, mm	Length, mm	Dia., mm	Pack Size
CH12322/1A	160 x 100	500	12	1
CH12322/3A	200 x 125	600	12	1
CH12322/5A	250 x 160	750	12	1



Spatula Chattaway S.S.

Cat No.	Size	Pack Size
CH12220/1	4"	6
CH12220/3	6"	6
CH12220/5	8"	6
CH12220/7	10"	6
CH12220/9	12"	6



Spatula One Side Spoon, One Side Flat S.S.

Cat No.	Size	Pack Size
CH12230/1	4"	6
CH12230/2	5"	6
CH12230/3	6"	6
CH12230/4	7"	6
CH12230/5	8"	6
CH12230/6	10"	6
CH12230/7	12"	6



Dissecting Forceps

- Stainless steel, ribbed sides, straight tips with fine points

Cat No.	Length, mm	Pack Size
B10951	100	10
B10953	125	10
B10955	150	10
B10957	200	10



Forceps

- Stainless steel, ribbed sides, straight, with blunt points

Cat No.	Length, mm	Pack Size
B10962/1	100	10
B10962/2	125	10
B10962/3	150	10
B10962/4	200	10



Test Tube Holder

- Plated spring steel wire with finger grip, with a wire collar to hold test tubes up to 38 mm

Cat No.	Pack Size
CH12695	12



Test Tube Holder

- Metal strips with a slider, mounted in wooden handle

Cat No.		Pack Size
CH12680/1	Brass	6
CH12680/3	Plated Steel	6



Test Tube Stand

- Aluminum, stackable pattern with five 28 mm, six 9 mm and eight 13 mm diam. holes arranged in three rows

Cat No.	Pack Size
CH12715	6



Test Tube Stands, Aluminium, Anodized

Cat. No.	No. of Holes	Dia. of Hole mm.	Pack Size
CH12721/1	12	12	1
CH12721/2	12	15	1
CH12721/3	12	18	1
CH12721/4	12	25	1
CH12721/5	24	12	1
CH12721/6	24	15	1
CH12721/7	24	18	1
CH12721/8	24	25	1
CH12721/9	36	12	1
CH12721/10	36	15	1
CH12721/11	36	18	1
CH12721/12	36	25	1
CH12721/13	48	12	1
CH12721/14	48	15	1
CH12721/15	48	18	1
CH12721/16	48	25	1
CH12721/17	72	12	1
CH12721/18	72	18	1
CH12721/19	72	25	1
CH12721/20	6	38	1
CH12721/21	12	38	1



Test Tube Stands, Made of Stainless Steel

Cat. No.	No. of Holes	Dia. of Hole mm.	Pack Size
CH12722/1	12	12	1
CH12722/2	12	15	1
CH12722/3	12	18	1
CH12722/4	12	25	1
CH12722/5	24	12	1
CH12722/6	24	15	1
CH12722/7	24	18	1
CH12722/8	24	25	1
CH12722/9	36	12	1
CH12722/10	36	15	1
CH12722/11	36	18	1
CH12722/12	36	25	1
CH12722/13	48	12	1
CH12722/14	48	15	1
CH12722/15	48	18	1
CH12722/16	48	25	1
CH12722/20	12	32	1



Bunsen Burner

- Nickel plated burner tube 100 x 12 mm, with adjustable screwed air regulator, riffling connector, mounted on a stove enamelled, pressed steel wide base of 80 mm dia. Overall height 125 mm
- With one spare jet

Cat No.		Pack Size
CH10600/1	For use with bottled, (LP) gas	1
CH10600/3	For use with natural gas	1



Bunsen Burner, With Stopcock

- Nickel plated burner tube 100 x 12 mm, with adjustable screwed air regulator, riffling connector, mounted on a stove enamelled, pressed steel wide base of 80 mm diam. overall height 125 mm With one spare jet. fitted with a stopcock in the inlet Tube to control flow of gas.

Cat No.		Pack Size
CH10604/1	LP (Bottled) Gas	1
CH10604/3	Natural Gas	1



Burner With Flame Stabilizer

- These burners control gas flow by a needle valve for easy flame adjustment. The stabilizer top allows gas to emerge at a low velocity in an annular ring acting as a pilot for the principal flame and steadying it.

Cat No.		Pack Size
CH10608/1	LP (Bottled) Gas	1
CH10608/3	Natural Gas	1



Bunsen Burner

- Nickel plated burner tube 115 x 13 mm, with rotatable air regulator, riffling connector, mounted on a stove enamelled, heavy die cast base of 80 mm dia, overall height approx. 140mm

Cat No.		Pack Size
CH10610/1	LP (Bottled) Gas	1
CH10610/3	Natural Gas	1



Bunsen Burner, Adjustable

- With one piece die-cast heavy base and riffled nozzle and adjustable gas and air inlets. A brass threaded needle valve and a rubber O ring for gas regulation, and air vents for air regulation. With flame retainer at top, for natural gas.

Cat. No.		Pack Size
CH10620/1	Natural Gas	1
CH10620/3	LP (Bottled) Gas	1



Burner Tirrill

- Tirrill burner allows adjustment of both gas and air supply resulting in a hotter flame. With a brass needle valve to adjust gas supply and adjustable air ports to regulate air supply. Can reach upto 1550°C

Cat. No.		Pack Size
CH10624/1	LP (Bottled) Gas	1
CH10624/3	Natural Gas	1



Meker Burner

- Superior quality, one piece die-cast base, with gas and air regulators, temperature upto 1750°C

Cat. No.		Pack Size
CH10625/1	LP (Bottled) Gas	1
CH10625/3	Natural Gas	1



Meker Burner, Heavy Base

- For high temperature work. Nickel plated burner tube with perforated plate of 25 mm diam. at top, which provides flame stability and ensures high and evenly distributed temperature. With rotatable air regulator around the jet. Heavy wide die cast metal base of 80 mm diam. With riffled gas inlet, overall height 150 mm.

Cat. No.		Pack Size
CH10630/1	LP (Bottled) Gas	1
CH10630/3	Natural Gas	1



Burner Methylated Spirit Stainless Steel, With Wick, 125 ml

Cat No.	Pack Size
CH10648/A/1	1



Alcohol Burner, Wickless

- A safe alternative to conventional alcohol burner, chrome plated tank has a screw top with rubber gasket. Uses a copper torch instead of a wick. capacity approx. 100 ml, fully leakproof.

Cat No.	Pack Size
CH10652	1



Gauze, Iron

- Ceramic Center, with folded edges

Cat. No.	Size, mm	Pack Size
CH11157/2	125 x 125	5
CH11157/5	150 x 150	5

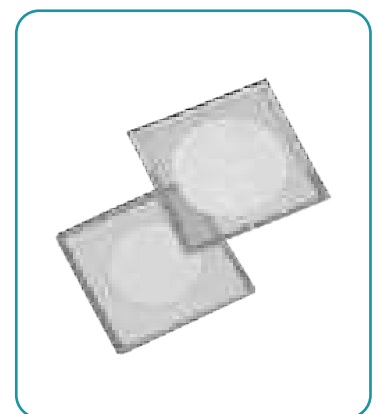

Hand Protectors

- Heat & cold resistant silicon rubber glove, with the help of this, one can easily handle heated up material like flask, bottles & beakers etc. Studded surface is used for positive grip of material with a temperature of 250°C. Pockets for fingers & thumb fit every hand size.

Cat No.	Pack Size
CH12032	1



Teats For Pipettes

- Rubber, with rolled edges, for use with dropping pipettes, pack of 100

Cat No.	Pack Size
CH11835	100



Pipette Bulb

- Made of rubber, with thick walled neck size small, medium, large extra large

Cat No.	Capacity Approx.	Pack Size
CH11838/1	5	10
CH11838/2	10	10
CH11838/3	15	10
CH11838/4	20	10
CH11838/5	25	10
CH11838/6	50	6
CH11838/7	100	6



Pipette bulb, Silicon Rubber

Cat No.	Capacity (Approx)	Pack Size
CH11839/1	5 ml	5
CH11839/2	10 ml	5
CH11839/3	15 ml	5
CH11839/4	20 ml	5
CH11839/5	25 ml	5
CH11839/6	50 ml	5
CH11839/7	100ml	5

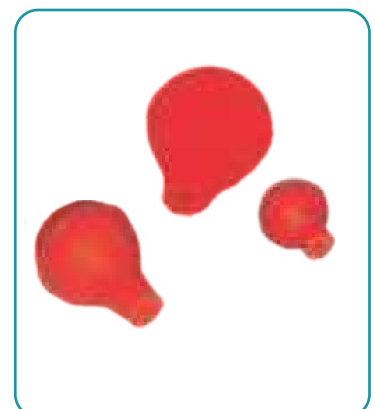

Pipette Filler

- Comprises a rubber bulb and three pinch valves, for use with pipettes upto 50 ml.

Cat. No.	Pack Size
CH11840	1



Burner Tube

- With reinforced ends for fitting to bunsen burner and gas tap

Cat. No.	Size, mm	Pack Size
CH10635/1	450	10
CH10635/2	600	10
CH10635/3	900	10
CH10635/4	1000	10



Neoprene Tube

- With thick ends for connecting to bunsen burner

Cat. No.	Size, mm	Pack Size
CH10635N/1	600	1
CH10635N/2	900	1



Rubber Tubing, Red

For general laboratory use, roll of 10 meter length

Cat. No.	Bore, mm	Wall thickness, mm	Pack Size
CH13064/1	4	1.0	1
CH13064/2	5	1.5	1
CH13064/3	6	1.5	1
CH13064/4	7	1.5	1
CH13064/5	8	1.5	1
CH13064/6	9	2.0	1
CH13064/7	10	2.0	1
CH13064/8	12	2.0	1



Rubber Tubing, Pressure

- For general laboratory use, roll of 10 meter length

Cat No.	Bore, mm	Wall thickness, mm	Pack Size
CH13065/2	3.0	3.0	1
CH13065/3	5.0	3.0	1
CH13065/4	6.0	3.0	1
CH13065/5	8.0	3.0	1
CH13065/6	9.0	3.0	1
CH13065/7	10.0	3.5	1
CH13065/8	12.5	4.5	1



Rubber Stoppers

- With number moulded in on each piece. Dimensions are approximate

Solid

Cat No.	No.	B. Dia., mm	T. Dia., mm	Ht	Pack Size
CH12500/1	000	6	9	16	10
CH12500/3	0	9	13	15.5	10
CH12500/4	1	11	14	18.5	10
CH12500/5	2	13	16.5	20	10
CH12500/6	3	14	19	21	10
CH12500/7	4	15	21	22	10
CH12500/8	5	17.5	22.5	23	10
CH12500/9	6	20	24.5	24	10
CH12500/10	7	20	26	27.5	10
CH12500/11	8	21	26.5	27.5	10
CH12500/12	9	21.5	28	31	10
CH12500/13	10	26	30	33	10
CH12500/14R	11	29	33	32	10
CH12500/15	12	30	34.5	34.5	10
CH12500/16	13	31	38.5	37	10
CH12500/17	14	32	41.5	42.5	10
CH12500/18R	15	38	42	40.5	10
CH12500/19R	16	35	45	36.5	10
CH12500/20	17	40	49.5	40.5	10
CH12500/21	18	48	53.5	33.5	10
CH12500/22R	19	44	58	45	10
CH12500/23	20	51	60	56.5	10



One Hole

Cat No.	No.	B. Dia., mm	T. Dia., mm	Ht	Pack Size
CH12510/1	000	6	9	16	10
CH12510/3	0	9	13	15.5	10
CH12510/4	1	11	14	18.5	10
CH12510/5	2	13	16.5	20	10
CH12510/6	3	14	19	21	10
CH12510/7	4	15	21	22	10
CH12510/8	5	17.5	22.5	23	10
CH12510/9	6	20	24.5	24	10
CH12510/10	7	20	26	27.5	10
CH12510/11	8	21	26.5	27.5	10
CH12510/12	9	21.5	28	31	10
CH12510/13	10	26	30	33	10
CH12510/14R	11	29	33	32	10
CH12510/15	12	30	34.5	34.5	10
CH12510/16	13	31	38.5	37	10
CH12510/17	14	32	41.5	42.5	10
CH12510/18R	15	38	42	40.5	10
CH12510/19R	16	35	45	36.5	10
CH12510/20	17	40	49.5	40.5	10
CH12510/21	18	48	53.5	33.5	10
CH12510/22R	19	44	58	45	10



Two Hole

Cat No.	No.	B. Dia., mm	T. Dia., mm	Ht	Pack Size
CH12520/3	0	9	13	15.5	10
CH12520/4	1	11	14	18.5	10
CH12520/5	2	13	16.5	20	10
CH12520/6	3	14	19	21	10
CH12520/7	4	15	21	22	10
CH12520/8	5	17.5	22.5	23	10
CH12520/9	6	20	24.5	24	10
CH12520/10	7	20	26	27.5	10
CH12520/11	8	21	26.5	27.5	10
CH12520/12	9	21.5	28	31	10
CH12520/13	10	26	30	33	10
CH12520/14R	11	29	33	32	10
CH12520/15	12	30	34.5	34.5	10
CH12520/16	13	31	38.5	37	10
CH12520/17	14	32	41.5	42.5	10
CH12520/18R	15	38	42	40.5	10
CH12520/19R	16	35	45	36.5	10
CH12520/20	17	40	49.5	40.5	10



Stoppers, Silicon Rubber

Cat No.	B. Dia., mm	T. Dia., mm	Height mm	Pack Size
CH12521/1	5	7	16	20
CH12521/2	6	9	16	20
CH12521/3	8	10.5	20	20
CH12521/4	9	11.5	20	20
CH12521/5	10	12.5	20	20
CH12521/6	11	14	24	20
CH12521/7	13	16	24	20
CH12521/8	15	18	24	20
CH12521/9	17	20	26	20
CH12521/10	18	21	26	20
CH12521/11	19	22.5	28	20
CH12521/12	21	24.5	28	20
CH12521/13	23	25.5	28	20
CH12521/14	25	28.5	28	10
CH12521/15	27	31	32	10
CH12521/16	29	33	32	10
CH12521/17	31	36	35	10
CH12521/18	33	38.5	38.5	10
CH12521/19	35	45.5	36.5	10
CH12521/20	38	42.5	40.5	10
CH12521/21	40	49.5	40.5	10



Stopper Suba Seal, Silicon Rubber, Autoclavable With Turn Over Flange and Serations for Test Tube

Cat No.	For Test Tube O.D. mm.	Pack Size
CH12522/1	12	10
CH12522/2	15	10
CH12522/3	18	10
CH12522/4	25	10



Stopper Suba Seal, Silicon Rubber, Autoclavable with Turn Over Flange, Plain

Cat No.	For Socket	Pack Size
CH12523/1	B-14	10
CH12523/2	B-19	10
CH12523/3	B-24	10
CH12523/4	B-29	10



Silicon Rubber Cone For Filtration Flask

Cat No.	Suitable for Filter Flask ml	Pack Size
CH12524/1	250	1
CH12524/2	500	1
CH12524/3	1000	1
CH12524/4	2000	1
CH12524/5	5000	1
CH12524/6	10000	1



Safety Rider for Volumetric Flask, Hexagonal Shape, Silicon Rubber

Cat No.	Color	Suitable for	Pack Size
CH12525/1	Yellow	5 - 25 ml	10
CH12525/2	Green	50 ml	10
CH12525/3	Blue	100 - 250 ml	10
CH12525/4	Orange	500 ml	10
CH12525/5	Red	1000 ml	10

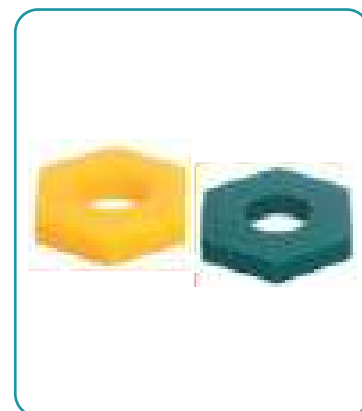

Tubing, Silicon Rubber

- Roll of 10 meter length

Cat No.	O.D., mm	Wall Thickness mm	Pack Size
CH13071/1	4	1	1
CH13071/2	5	1	1
CH13071/3	6	1	1
CH13071/4	7	1	1
CH13071/5	7	1.5	1
CH13071/6	8	1	1
CH13071/7	8	1.5	1
CH13071/8	8	2	1
CH13071/9	9	1.5	1
CH13071/10	10	1.5	1
CH13071/11	10	2	1
CH13071/12	11	1.5	1
CH13071/13	11	2	1
CH13071/14	12	2	1
CH13071/15	12	3	1
CH13071/16	14	2	1
CH13071/17	14	3	1
CH13071/18	16	2	1
CH13071/19	16	3	1
CH13071/20	19	3.5	1
CH13071/21	23	4	1



Brushes

Brush, Beaker

- Hard nylon bristles on twisted G.I. wire, head 140 x 63 mm, overall length 400 mm approx.

Cat No.	Pack Size
CH10305	1

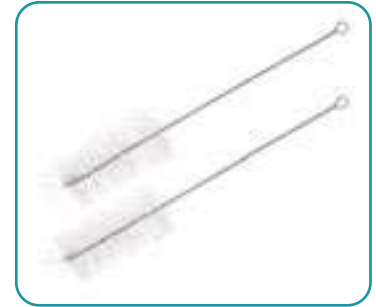

Brush, Beaker

- Hard nylon bristles on stainless steel wire, head 150 x 85 mm, overall length 400 mm.

Cat No.	Pack Size
CH10307	1

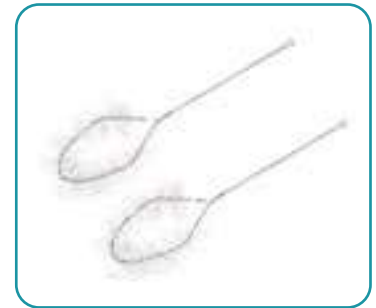

Brush, Beaker

- Hard nylon bristles on wooden handle, head 150 x 75 mm, overall length 325 mm approx.

Cat No.	Pack Size
CH10309	1



Brush, Bottle

- Hard nylon bristles, mounted on twisted G.I. wire, head 120 x 65 mm, overall length 500 mm.

Cat No.	Pack Size
CH10310	1



Brush, Burette

- Hard nylon bristles, mounted on twisted G.I. wire, Available in following sizes

Cat No.	Pack Size
CH10314/1	Head 15 X 150 mm., overall length 900 mm
CH10314/3	Head 25 X 150 mm., overall length 915 mm



Brush, Test Tube

- Hard nylon bristles, mounted on twisted G.I. wire, head 90 x 45 mm., overall length 250 mm.

Cat No.	Pack Size
CH10317	10



Brush, Semi Micro Test Tubes

- For small test tube of 6-10 mm diam., head 10 x 70 mm, overall length 175 mm. Nylon White

Cat No.	Pack Size
CH10319	10



Brush, Flask

- Hard nylon bristles, mounted on twisted G.I. wire, head 130 x 50 mm. overall length 360 mm.

Cat No.	Pack Size
CH10320	1



Brush, Flask

- For round bottom flask upto 100 mm diam., Nylon bristles on twisted G.I. wire handle. Overall length 330 mm.

Cat No.	Pack Size
CH10322	1



Brush, Pipette

- Nylon Bristles on twisted G.I. Wire, head size 125 x 10 mm, overall length 650 mm for pipettes and tubes from 8-12 mm dia.

Cat No.	Pack Size
CH10324	1



SURGICAL DISPOSABLE MASK - TYPE IIR



Product Description

- Composed of 3 layers of ultra-soft, splash-resistant PP non-woven fabric (TNT). Bacterial filtration efficiency (BFE) $\geq 98\%$. This type of masks complies with the highest performance requirements for face masks (Type IIR) and can be used in a medical environment.
- Elastic earloops hold the mask right and comfortable to the face and allow for easy removal. Adapting the integrated nose bar to the nose silhouette seals off the upper face and eye area.
- To improve breathability, fit & to avoid irritation on the cheeks we recommend to keep the ear loop welding points on the outer side.

Key Features

- Outer Hydrophobic Non-Woven Layer
- Middle Melt Blown Layer
- Inner Soft Absorbent Non-Woven Layer

Cat No.	Pack Size
SDM-IIR	50

SYRINGE FILTERS

Syringe Filters

Syringe filters are single-use, membrane-based filtration device. **supertek**[®] offers a wide range of syringe filters with different options of membrane, diameter and pore size. commonly used for fast and efficient filtration, this helps to purify the sample for analysis by removing the particulates from the solution.

Key Features :

- High Flow Rates
- 16 Channels for minimum back pressure
- Absolute Microbial Retention
- Wide Chemical Compatibility
- Very low Extractable

Membrane

- Nylon
- Hydrophobic PTFE
- PVDF
- Polyethersulfone
- Microglassfiber

Diameter

- 25mm
- 13mm

Pore Size (Colour Coding)

- 0.22µm (Pink)
- 0.45µm (Blue)



Other specified products are available on request.

All variants are also available as Individually Packed Pre-Sterilized (ETO).

Non Sterile, Single Layered syringe filters Diameter – 25mm

Cat. No.	Membrane	Diameter, mm	Pore size, μm	Pack size
SNY02-N25	Nylon	25	0.22	100
SNY04-N25	Nylon	25	0.45	100
SPT02-N25	PTFE	25	0.22	100
SPT04-N25	PTFE	25	0.45	100
SPV02-N25	PVDF	25	0.22	100
SPV04-N25	PVDF	25	0.45	100
SPE02-N25	Polyethersulfone (PES)	25	0.22	100
SPE04-N25	Polyethersulfone (PES)	25	0.45	100
SGF1-N25	Glass Fiber	25	1.0	100

Non Sterile, Double Layered syringe filters Diameter – 25mm

Cat. No.	Membrane	Diameter, mm	Pore size, μm	Pack size
SNYG02-N25	Nylon with Glass Fiber	25	0.22	100
SNYG04-N25	Nylon with Glass Fiber	25	0.45	100
SPTG02-N25	PTFE with Glass Fiber	25	0.22	100
SPTG04-N25	PTFE with Glass Fiber	25	0.45	100
SPVG02-N25	PVDF with Glass Fiber	25	0.22	100
SPVG04-N25	PVDF with Glass Fiber	25	0.45	100
SPEG02-N25	PES with Glass Fiber	25	0.22	100
SPEG04-N25	PES with Glass Fiber	25	0.45	100

Non Sterile, Single Layered syringe filters Diameter – 13mm

Cat. No.	Membrane	Diameter, mm	Pore size, μm	Pack size
SNY02-N13	Nylon	13	0.22	100
SNY04-N13	Nylon	13	0.45	100
SPT02-N13	PTFE	13	0.22	100
SPT04-N13	PTFE	13	0.45	100
SPV02-N13	PVDF	13	0.22	100
SPV04-N13	PVDF	13	0.45	100
SPE02-N13	Polyethersulfone (PES)	13	0.22	100
SPE04-N13	Polyethersulfone (PES)	13	0.45	100
SGF1-N13	Glass Fiber	13	1.0	100

Non Sterile, Double Layered syringe filters Diameter – 13mm

Cat. No.	Membrane	Diameter, mm	Pore size, μm	Pack size
SNYG02-N13	Nylon with Glass Fiber	13	0.22	100
SNYG04-N13	Nylon with Glass Fiber	13	0.45	100
SPTG02-N13	PTFE with Glass Fiber	13	0.22	100
SPTG04-N13	PTFE with Glass Fiber	13	0.45	100
SPVG02-N13	PVDF with Glass Fiber	13	0.22	100
SPVG04-N13	PVDF with Glass Fiber	13	0.45	100
SPEG02-N13	PES with Glass Fiber	13	0.22	100
SPEG04-N13	PES with Glass Fiber	13	0.45	100

Sterile, Single Layered syringe filters Diameter – 25mm

Cat. No.	Membrane	Diameter ,mm	Pore size, μm	Pack size
SNY02-S25	Nylon	25	0.22	100
SNY04-S25	Nylon	25	0.45	100
SPT02-S25	PTFE	25	0.22	100
SPT04-S25	PTFE	25	0.45	100
SPV02-S25	PVDF	25	0.22	100
SPV04-S25	PVDF	25	0.45	100
SPE02-S25	Polyethersulfone (PES)	25	0.22	100
SPE04-S25	Polyethersulfone (PES)	25	0.45	100
SGF1-S25	Glass Fiber	25	1.0	100

Sterile, Double Layered syringe filters Diameter – 25mm

Cat. No.	Membrane	Diameter, mm	Pore size, μm	Pack size
SNYG02-S25	Nylon with Glass Fiber	25	0.22	100
SNYG04-S25	Nylon with Glass Fiber	25	0.45	100
SPTG02-S25	PTFE with Glass Fiber	25	0.22	100
SPTG04-S25	PTFE with Glass Fiber	25	0.45	100
SPEG02-S25	PES with Glass Fiber	25	0.22	100
SPEG04-S25	PES with Glass Fiber	25	0.45	100
SPVG02-S25	PVDF with Glass Fiber	25	0.22	100
SPVG04-S25	PVDF with Glass Fiber	25	0.45	100

Sterile, Single Layered syringe filters Diameter – 13mm

Cat. No.	Membrane	Diameter, mm	Pore size, μm	Pack size
SNY02-S13	Nylon	13	0.22	100
SNY04-S13	Nylon	13	0.45	100
SPT02-S13	PTFE	13	0.22	100
SPT04-S13	PTFE	13	0.45	100
SPV02-S13	PVDF	13	0.22	100
SPV04-S13	PVDF	13	0.45	100
SPE02-S13	Polyethersulfone (PES)	13	0.22	100
SPE04-S13	Polyethersulfone (PES)	13	0.45	100
SGF1-S13	Glass Fiber	13	1.0	100

Sterile, Double Layered syringe filters Diameter – 13mm

Cat. No.	Membrane	Diameter, mm	Pore size, μm	Pack size
SNYG02-S13	Nylon with Glass Fiber	13	0.22	100
SNYG04-S13	Nylon with Glass Fiber	13	0.45	100
SPTG02-S13	PTFE with Glass Fiber	13	0.22	100
SPTG04-S13	PTFE with Glass Fiber	13	0.45	100
SPEG02-S13	PES with Glass Fiber	13	0.22	100
SPEG04-S13	PES with Glass Fiber	13	0.45	100
SPVG02-S13	PVDF with Glass Fiber	13	0.22	100
SPVG04-S13	PVDF with Glass Fiber	13	0.45	100

MEMBRANE FILTERS

Membrane filters are widely used to sterilize liquids. It is an effective, accepted technique for the filtration of fluid samples. We can determine the quality of water and the quantity of microorganisms by using this membrane filter. It is also known as the molecular or biological filter.

Cat No.	Membrane	Pore Size, μm	Diameter, mm	Pack Size
MNY02-N25	Nylon	0.22	25	100
MNY04-N25	Nylon	0.45	25	100
MNY02-N47	Nylon	0.22	47	100
MNY04-N47	Nylon	0.45	47	100
MCN02-N25	Cellulose Nitrate	0.22	25	100
MCN04-N25	Cellulose Nitrate	0.45	25	100
MCN02-N47	Cellulose Nitrate	0.22	47	100
MCN04-N47	Cellulose Nitrate	0.45	47	100

Gridded-Indiv. Packed-ETO Sterile Membrane

Cat No.	Membrane	Pore Size, μm	Diameter mm	Pack Size
MCN04-S47	Cellulose Nitrate	0.45	47	100



Equipment



Power up your Experiments with our Equipment

Heating Mantles, Analog

Heating mantles are used to uniformly heat liquids placed in round bottom flasks.

Features :

- Heat liquid solutions placed in round bottom flasks
- For use with round bottom, flasks
- Outer body is made from powder coated rolled aluminium
- Glass fibre yarn knitted heating element provides uniform heating to flask
- Heat is controlled with in-built electronic circuit card
- Includes support rods and boss head
- With non-slip rubber feet

Technical Specifications

- Temperature range of heating surface: Ambient + 5°C to 350°C
- Overload protection
- Input voltage: 220 V AC ± 10%, 50-60 Hz
- CE certified

Cat No.	Flask Capacity, ml	Power Consumption /Rating (W)	Pack Size
CH11161/1	50	60	1
CH11161/2	100	60	1
CH11161/3	250	150	1
CH11161/4	500	200	1
CH11161/5	1000	300	1
CH11161/6	2000	450	1
CH11161/7	3000	450	1
CH11161/8	5000	600	1



Heating Mantles, Digital

Heating mantles are used to uniformly heat liquids placed in round bottom flasks. Insert the external probe in the liquid solution and measure / control the temperature of liquid directly with these highly accurate digital heating mantles.

Features :

- Measure and control the temperature of liquid directly
- For use with round bottom flasks
- Outer body is made from powder coated rolled aluminium
- Glass fibre yarn knitted heating element provides uniform heating to flask
- Precise temperature control with PID controller
- LED display for showing actual and set temperature
- Temperature probe PT100
- Includes support rods and boss head
- With non-slip rubber feet

Technical Specifications

- Temperature range: Ambient + 5°C to 350°C, Resolution 0.1°C
- Temperature accuracy ± 0.5°C
- Overload protection
- Input voltage: 220 V AC ± 10%, 50-60 Hz
- CE certified

Cat No.	Flask Capacity, ml	Power Consumption /Rating (W)	Pack Size
CH11161D/1	50	60	1
CH11161D/2	100	60	1
CH11161D/3	250	150	1
CH11161D/4	500	200	1
CH11161D/5	1000	300	1
CH11161D/6	2000	450	1
CH11161D/7	3000	450	1
CH11161D/8	5000	600	1



Note: The heating element cording may be slightly brown in color. This is a result of testing during the QC process.

Heating Mantle with Stirrer, Analog

Analog heating mantle with stirrer are used to simultaneously heat and stir liquid solutions placed in round bottom flasks.

Features :

- Heat and stir liquid solutions simultaneously
- For use with round bottom flasks
- Outer body is made from powder coated rolled aluminium
- Glass fibre yarn knitted heating element provides uniform heating to flask
- Stirring is done using a magnetic bar
- Integrated electronic circuit card for heating and stirring
- Includes support rods and boss heads
- With non-slip rubber feet

Technical Specifications

- Stirring speed: Upto 1200 RPM
- Temperature range of heating surface: Ambient + 5°C to 350°C
- Overload protection
- Input voltage: 220 V AC \pm 10%, 50-60 Hz
- CE certified

Cat No.	Flask Capacity, ml	Power Consumption /Rating (W)	Pack Size
CH11172/1	50	60	1
CH11172/2	100	60	1
CH11172/3	250	150	1
CH11172/4	500	200	1
CH11172/5	1000	300	1
CH11172/6	2000	450	1
CH11172/7	3000	450	1
CH11172/8	5000	600	1



Heating Mantle with Stirrer, Digital

Digital heating mantle with stirrer are used to simultaneously heat and stir liquid solutions placed in round bottom flasks. Insert the external probe in the liquid solution and measure / control the temperature of liquid directly.

Features :

- Stir and measure / control the temperature of liquid directly
- For use with round bottom flasks
- Outer body is made from powder coated rolled aluminium
- Glass fibre yarn knitted heating element provides uniform heating to flask
- Precise temperature control with PID controller
- LED display for showing actual and set temperature
- Temperature probe PT100
- Stirring is done using a magnetic bar
- Includes support rods and boss head
- With Non-slip rubber feet

Technical Specifications

- Stirring speed: Upto 1200 RPM
- Temperature range: Ambient + 5°C to 350°C, Resolution 0.1°C.
- Temperature accuracy \pm 0.5°C
- Overload protection
- Input voltage: 220 V AC \pm 10%, 50-60 Hz
- CE certified

Cat No.	Flask Capacity, ml	Power Consumption /Rating (W)	Pack Size
CH11172D/1	50	60	1
CH11172D/2	100	60	1
CH11172D/3	250	150	1
CH11172D/4	500	200	1
CH11172D/5	1000	300	1
CH11172D/6	2000	450	1
CH11172D/7	3000	450	1
CH11172D/8	5000	600	1



Note: The heating element cord may be slightly brown in color. This is a result of testing during the QC process.

Fabric Heating Mantles

Fabric heating mantles provide even heating to round shaped vessels. They provide maximum surface coverage for better temperature uniformity. Fabric heating mantles require a controlled electrical power source to prevent from overheating.

Features :

- For use with round bottom flasks
- Fabric construction
- Glass fibre yarn knitted mantle provides sustainable and uniform heating to flask
- Reduces the chance of thermal shocks and damage to glassware
- Space saving design
- Requires fabric heating mantle controller, CH11160C/2 (not included)

Technical Specifications

- Temperature range of heating surface: Ambient + 5°C to 350°C
- CE certified

Cat No.	Flask Capacity,ml	Power Consumption /Rating (W)	Pack Size
CH11160/1	50	60	1
CH11160/2	100	80	1
CH11160/3	250	180	1
CH11160/4	500	270	1
CH11160/5	1000	380	1
CH11160/6	2000	500	1
CH11160/7	3000	500	1
CH11160/8	5000	500	1

Note: The heating element cording may be slightly brown in color. This is a result of testing during the QC process.

New



Fabric Heating Mantle Controller

Control the heat output of the fabric heating mantles with this controller.

Features :

- For use with fabric heating mantles
- Compact and safe design
- Adjustable knob for heat control
- Up to 1.6 kW load can be controlled
- Input voltage: 220 V AC ± 10%, 50-60 Hz
- CE certified

Cat No.	Pack Size
CH11160C/2	1

New



Heating Mantles, Multi-position

Multi position heating mantles are used to heat multiple round bottom flasks simultaneously.

Features :

- Available in 3 and 6 positions
- Space saving design
- Outer body is made of powder coated mild steel
- Glass fibre yarn knitted heating element provides uniform heating to flask
- For use with round bottom flasks
- Each position has an independent heat control knob
- Heat is controlled with in-built electronic circuit card
- Includes support rods and boss heads
- With non-slip rubber feet

Technical Specifications

- Temperature range of heating surface: Ambient + 5°C to 350°C
- Overload protection
- Input voltage: 220 V AC \pm 10%, 50-60 Hz
- CE certified

Cat No.	No. of Position	Flask Capacity, ml	Watts	Pack Size
CH11162A/1	3	100	180	1
CH11162A/2	3	250	450	1
CH11162A/3	3	500	600	1
CH11162A/4	3	1000	900	1
CH11162B/1	6	100	360	1
CH11162B/2	6	250	900	1
CH11162B/3	6	500	1200	1
CH11162B/4	6	1000	1800	1

Note : The heating element cording may be slightly brown in color. This is a result of testing during the QC process.



Laboratory Hot Plate, Round

This laboratory hot plate is used for general purpose heating requirements.

Features :

- For general purpose heating requirements
- Round shaped, cast iron heating plate
- Powder coated mild steel body
- Heat is controlled with in-built electronic circuit card
- Includes support rods and clamps
- With non-slip rubber feet

Technical Specifications

- Maximum temperature of hot plate: Upto 350°C
- Overload protection
- Input voltage: 220 V AC \pm 10%, 50-60 Hz
- CE certified

Cat No.	Plate Size	Power Rating (W)	Pack Size
CH11168B/2	20 cm (8")	800	1



Laboratory Hot Plate, Rectangular, Analog

These rectangular hot plates with large surface area can be used for heating multiple solutions simultaneously

Features :

- For heating multiple solutions simultaneously
- Rectangular shaped, cast iron heating plate
- Powder coated mild steel body
- Heat is controlled with in-built electronic circuit card
- Includes support rods and clamps
- With non-slip rubber feet

Technical Specifications

- Maximum temperature of hot plate: Upto 350°C
- Overload protection
- Input voltage: 220 VAC ± 10%, 50-60 Hz
- CE certified

Cat No.	Plate Size	Power Rating (W)	Pack Size
CH11170/1	30 x 25 cm (12" x 10")	1200	1
CH11170/2	40 x 25 cm (16" x 10")	1200	1
CH11170/3	45 x 30 cm (18" x 12")	1600	1
CH11170/4	65 x 56 cm (24"x 18")	2400	1



Laboratory Hot Plate, Rectangular, Digital

These rectangular hot plates, with large surface area can be used for heating multiple solutions simultaneously. Insert the external probe in the liquid solution and measure / control the temperature of liquid directly.

Features :

- For heating multiple solutions simultaneously
- Measure and control the temperature of liquid solution directly
- Rectangular shaped, cast iron heating plate
- Powder coated mild steel body
- Precise temperature control with PID controller
- LED display for showing actual and set temperature
- Temperature probe PT100
- Includes support rods and clamps
- With non-slip rubber feet

Technical Specifications

- Temperature range: Ambient + 5°C to 350°C, Resolution 0.1°C.
- Temperature accuracy ± 0.5°C
- Overload protection
- Input voltage: 220 VAC ± 10%, 50-60 Hz
- CE certified

Cat No.	Plate Size	Power Rating (W)	Pack Size
CH11170D/1	30 x 25 cm (12" x 10")	1200	1
CH11170D/2	40 x 25 cm (16" x 10")	1200	1
CH11170D/3	45 x 30 cm (18" x 12")	1600	1
CH11170D/4	65 x 56 cm (24"x 18")	2400	1



Laboratory Hot Plate, Advanced

The advanced hot plate with glass ceramic hot plate is used for heating highly reactive solutions.

Features :

- Measure and control the temperature of highly reactive liquid solutions directly with the help of probe
- Glass ceramic offers excellent chemical resistance against strong acid and bases
- Spill proof design
- Precise temperature control with PID controller
- LED display for showing actual and set temperature
- Temperature probe PT1000
- Includes support rods and clamps
- With non-slip rubber feet

Technical Specifications

- Top Plate: Chemical resistant glass ceramic plate
- Top Plate Dimensions: 180 x 180 mm
- Max. Capacity: 10 L
- Power Rating: 1000 W
- Temperature range of top surface: Ambient + 5°C, Resolution 0.1°C
- Hot plate indication
- Selection of hot plate and probe temperature
- Independent display for Set and Actual Temperature
- Overload protection
- Input voltage: 220 V AC \pm 10%, 50-60 Hz
- CE certified

Cat No.	Pack Size
CH11171D/2	1



Hot Plate Magnetic Stirrer

Hot plate magnetic stirrer is used for simultaneous heating and stirring of solutions.

Features :

- Heating and stirring of liquid solutions
- Top plate is available in 2 materials: Silver anodized aluminium and Ceramic coated stainless steel
- Ceramic coating offers chemical resistance against strong acid and bases
- Stirring is done by DC motor
- Independent analog controls for heating and stirring
- Integrated circuit for precise control of heating and stirring
- Spill proof design
- High quality, fine finished textured powder coated aluminium body
- Teflon coated stirring bar
- Includes support rod and clamps
- With non-slip rubber feet

Technical Specifications

- Top Plate Dimensions: 120 x 120 mm (500ml), 180 x 180 mm (5L)
- Temperature range of top plate: Upto 380°C
- Stirring speed: Upto 1500 RPM
- Input voltage: 220 V AC \pm 10%, 50-60 Hz
- CE certified

Cat No.	Capacity	Top Plate Material	Max. Temperature of top plate (°C)	Pack Size
CH12395B/2A	500ml	Aluminium	350	1
CH12395B/2C	500ml	Ceramic Coated	380	1
CH12395H/2A	5L	Aluminium	350	1
CH12395H/2C	5L	Ceramic Coated	380	1



Hot Plate Magnetic Stirrer, Digital

Digital hot plate magnetic stirrer is used for simultaneous heating and stirring of solutions.

Features :

- Measure and control the temperature of either hot plate or liquid solution
- LED display for showing actual / set temperature and RPM
- Top plate is available in 2 materials: Silver anodized aluminium and Ceramic coated stainless steel
- Ceramic coating offers chemical resistance against strong acid and bases
- Stirring is done by DC motor
- Independent control for heating and stirring
- Integrated circuit for precise control of heating and stirring
- Selection of hot plate and probe temperature
- Spill proof design
- High quality, fine finished textured powder coated aluminium body
- Temperature probe PT100
- Includes support rods and clamps
- With non-slip rubber feet

Technical Specifications

- Top Plate Dimensions: 180 x 180 mm
- Temperature range of top plate: Upto 380°C, Resolution 1°C
- Temperature accuracy $\pm 1^\circ\text{C}$
- Heater Rating: 800 W
- Stirring speed: Upto 1500 RPM
- Input voltage: 220 V AC $\pm 10\%$, 50-60 Hz
- CE certified

Cat No.	Capacity	Top Plate Material	Max. Temperature of top plate ($^\circ\text{C}$)	Pack Size
CH12395D/2A	5L	Aluminium	350	1
CH12395D/2C	5L	Ceramic Coated	380	1



Hot Plate Magnetic Stirrer, Advanced

The advanced hot plate magnetic stirrer with glass ceramic hot plate is used for heating and stirring highly reactive solutions.

Features :

- Measure and control the temperature of either hot plate or liquid solution
- LED display for showing actual temperature and RPM
- Top Plate Material: Glass ceramic
- Glass ceramic offers excellent chemical resistance against strong acid and bases
- Stirring is done using BLDC motor
- Precise temperature control & stirring with microprocessor based controller
- Selection of hot plate and probe temperature
- Hot plate indication
- Spill proof design
- High quality, fine finished textured powder coated aluminium body
- Temperature probe PT1000
- Includes support rods and clamps
- With non-slip rubber feet

Technical Specifications

- Top Plate: Chemical resistant glass ceramic plate
- Top Plate Dimensions: 180 x 180 mm
- Max. Capacity: 5L
- Heater Rating: 800 W
- Temperature range of top surface: Ambient + 5°C to 520°C, Resolution 1°C
- Stirring Speed: Upto 1500 RPM
- Overload protection
- Input voltage: 220 V AC $\pm 10\%$, 50-60 Hz
- CE certified

Cat No.	Pack Size
CH12395H/2G	1



Magnetic Stirrer

Stirrers are used in laboratory to mix liquid solutions and thereby speed up the reactions.

Features :

- Stainless steel top surface
- Continuously variable stirring speed
- Spill proof design
- Includes teflon coated stirring bar

Technical Specifications

- Maximum capacity: Upto 2L
- Stirring Speed: Upto 1500 RPM
- Input voltage: 220 VAC \pm 10%, 50-60 Hz
- CE certified

Cat No.	Pack Size
CH12393	1



PTFE coated magnetic stirring bar

Cat. No.	Dia. x Length (mm)	Pack Size
CHPTFE12/1	5 x 10	2
CHPTFE12/2	6 x 10	2
CHPTFE12/3	6 x 18	2
CHPTFE12/4	7 x 15	2
CHPTFE12/5	8 x 14	2
CHPTFE12/6	8 x 20	2
CHPTFE12/7	8 x 25	2
CHPTFE12/8	8 x 30	2
CHPTFE12/9	8 x 35	2
CHPTFE12/10	8 x 40	2
CHPTFE12/11	9 x 20	2
CHPTFE12/12	9 x 25	2
CHPTFE12/13	9 x 35	2
CHPTFE12/14	9.5 x 50	2
CHPTFE12/15	9.5 x 75	2
CHPTFE12/16	9.5 x 90	2
CHPTFE12/17	13 x 50	2
CHPTFE12/18	13 x 75	2
CHPTFE12/19	13 x 100	2
CHPTFE12/20	16 x 65	2
CHPTFE12/21	16 x 101	2
CHPTFE12/22	16 x 127	2



New

PTFE Coated Magnetic Stirring Bar (Octogonal)

Cat. No.	Dia. x Length (mm)	Pack Size
CHPTFE13/2	8x13	2
CHPTFE13/6	8x19	2
CHPTFE13/8	8x30	2
CHPTFE13/12	8x51	2



Vortex Mixer

A vortex mixer, or vortexer, is a simple device used commonly in laboratories to mix small vials of liquid.

Features :

- Vortex Mixer operates in 2 modes: Touch and Continuous
- Adjustable speed range
- Orbital movement
- Maximum diameter of tube: Upto 30mm
- Heavy construction for stable and reliable operation

Technical Specifications

- Shaking Stroke: 4 mm
- Speed Range: Upto 2000 RPM
- Input Voltage 220 V AC \pm 10%, 50-60 Hz
- CE Certified

Cat No.	Mode	Pack Size
CH12400TC	Touch and Continuous	1



Digital Autoclave, Heavy Duty

Autoclave provides a physical method for disinfection and sterilization. It sterilizes using a combination of steam, pressure and time to kill micro-organisms and spores. It is used in healthcare and industrial applications.

Features :

- Heavy duty stainless steel chamber
- Lid locks with the chamber against a rubber gasket using swivel wing nut bolts
- PID for precise temperature control
- LED display for showing actual and set temperature
- Low water level indicator with automatic cut off
- The top lid is fitted with pressure gauge and two safety valves

Technical Specifications

- Capacity: 20 L
- Stainless steel chamber wall thickness: 3 mm
- Overall size: 500 x 400 x 500 mm (L x W x H)
- Container size: 300 x 300 mm (OD x H)
- Heater: 2 kW
- Pressure: 15 psi / 22 psi
- Working temperature: 121°C – 140°C
- Sterilization time: 15 to 20 mins
- Overload protection
- Input voltage: 220 V AC \pm 10%, 50-60 Hz
- CE certified

Cat No.	Pack Size
CH11027D	1



Laboratory Incubator, Forced Convection

Laboratory incubators are used for incubating microbiological cultures. These incubators ensure stable and reliable incubation; and guarantee reproducible results for routine tests in the laboratory. Forced air convection offers higher temperature uniformity, lesser energy consumption and quicker set temperatures as compared to natural convection.

Features :

- Quality Construction
 - * Stainless steel interior
 - * Powder coated exterior
- PID controller for precise temperature control
- Forced air convection produces faster temperature response rates, improves uniformity and reduces fluctuation
- Manually adjustable air flow rate
- Superior insulation for lower energy consumption and better performance
- Glass door for observing samples inside the chamber during operation
- Process Timer
- Open door alert
- Fan failure alert
- Low noise level
- Low maintenance

Technical Specifications

- Temperature range: Ambient +5° to 70°C, Resolution 0.1°C
- Temperature accuracy $\pm 0.5^\circ\text{C}$
- Maximum shelf load: 15 Kg
- Overload protection
- Input voltage: 220 VAC $\pm 10\%$, 50-60 Hz
- CE certified

Cat No.	Capacity, L	Power Rating, W	Chamber Size, mm Ltrs. (L x W x H)	NO. of shelves	Pack Size
CH11175F/1	27	400	300 x 300 x 300	2	1
CH11175F/2	45	400	355 x 355 x 355	2	1
CH11175F/3	60	800	450 x 300 x 450	2	1
CH11175F/4	90	800	450 x 450 x 450	3	1
CH11175F/5	120	800	450 x 450 x 600	3	1
CH11175F/6	160	800	600 x 450 x 600	3	1
CH11175F/7	215	800	600 x 600 x 600	3	1
CH11175F/8	240	800	625 x 625 x 625	3	1

* Also available in SS



Triple Water Baths

Triple water baths feature three independently controlled unstirred water baths in one unit.

Features :

- Includes three high quality, corrosion resistant and easily cleanable seamless stainless steel tanks
- Outer body is made of powder coated mild steel
- Each tank is independently controlled by in-built electronic circuit card
- Each tank includes flat stainless steel cover and perforated shelf
- Process indication
- Low water indication with auto cut off
- With non-slip rubber feet

Technical Specifications

- Temperature range: Ambient + 5°C to 99°C, Resolution 0.1°C.
- Temperature accuracy $\pm 0.5^\circ\text{C}$
- Overload protection
- Input voltage: 220 VAC $\pm 10\%$, 50-60 Hz
- CE certified

Cat No.	Capacity	Power Rating	Pack Size
CH10124T/6	3 x 6 L	1200 W	1



Unstirred Water Baths, Digital

These unstirred water baths are ideal for general laboratory use. The water baths are economical, reliable and have high temperature accuracy.

Features :

- High quality, corrosion resistant and easily cleanable seamless stainless steel tank
- Outer body is made of powder coated mild steel
- Includes flat stainless steel cover, perforated shelf and a drain outlet
- PID controller for precise temperature control
- LED display for showing actual and set temperature
- With non-slip rubber feet

Technical Specifications

- Temperature range: Ambient + 5°C to 99°C, Resolution 0.1°C
- Temperature accuracy ± 0.5°C
- Overload protection
- Input voltage: 220 VAC ± 10%, 50-60 Hz
- CE certified

Cat No.	Capacity,L	Tank Size (Inner), mm (L x W x H)	Heater Rating, W	Pack Size
CH10124D/6	6	290 x 230 x 110	500	1
CH10124D/1	12	330 x 300 x 160	1000	1
CH10124D/2	24	500 x 300 x 160	1500	1
CH10124D/3	48	620 x 500 x 160	2500	1

Accessories

Concentric Ring Lids

Cat No.	Holes	Fits with Water Bath	Pack Size
WB-ACC-LH4	4 x 80 mm	6 L	1
WB-ACC-LH6	6 x 80 mm	12 L	1
WB-ACC-LH12	12 x 80 mm	24 L	1

Ultrasonic Baths

Ultrasonic baths are commonly used in scientific, laboratory, medical, electronic, jewellery and dental industries where precision cleaning is required.

Features :

- Stainless steel outer construction
- Includes stainless steel tanks with lid, drain outlet and immersion basket
- Microcontroller based digital ultrasonic control circuit
- High quality transducers ensure high electro-acoustical efficiency and low heat generation
- Includes heater for thermostatic heating
- Digital timer
- Simple to use interface
- Easy to read digital display
- With non-slip rubber feet

Technical Specifications

- Operating frequency: 40 ± 3 kHz
- Temperature range: Ambient + 5°C to 65°C
- Timer Range: 1 to 15 mins
- Input voltage: 220 VAC ± 10%, 50-60 Hz
- CE certified

Cat No.	Capacity, L	Heating Power, W	Ultrasonic Power, W	Tank Size (L x W x H), mm	Weight, Kg	Pack Size
USB-D-1.5L	1.5	60	60	240 x 140 x 65	3	1
USB-D-3L	3	120	120	300 x 150 x 100	5	1
USB-D-6.5L	6.5	150	150	300 x 240 x 100	10	1
USB-D-9L	9	250	250	300 x 240 x 150	12	1
USB-D-15L	15	300	400	350 x 300 x 150	15	1



Digital Laboratory Oven

Digital laboratory oven is used for high-volume thermal convection applications. The inner chamber is performed for natural convection air flow which assures constant temperature in the system. Temperature up to 250°C. Standard double wall fabrication. Inner chamber made out of highly polished stainless steel sheet and outer made out of mild steel finished in white stoving enamel. The gap between the two walls is filled with high-grade glass wool.

Features :

- Programmable digital temperature indicator cum controller.
- Timer with Led indicator.
- Load Indicator.
- Illuminated On/Off switch.
- High precision sensor.
- Accuracy $\pm 3^{\circ}$ C.
- Adjustable perforated shelves made of stainless steel.
- Air circulating fan in selected models.
- Superior insulation that improves chamber stability and reduces heat loss.
- High-quality eccentric hinge ensures maximum gasket compression for stable chamber temperature.

Cat No.	Size mm (L X W X H)	No. of Shelves	Capacity Ltrs.	Pack Size
CH11811C/1	300 x 300 x 300	2	27	1
CH11811C/3	300 x 350 x 350	2	45	1
CH11811C/4F*	450 x 450 x 450	2	95	1
CH11811C/5F*	450 x 600 x 450	2	125	1
CH11811C/6F*	600 x 600 x 600	2	215	1
CH11811C/7F*	600 x 900 x 450	3	240	1
CH11811C/8F*	600 x 900 x 600	3	325	1

Note: "F" in Cat No. indicates the models with in-built air circulating fan.



UV Cabinet

The UV Cabinet is a desktop disinfection device, offering simple operation and compact dimensions. Its application is for the UV type C disinfection of small tools and objects. The device contains two internal UV type C lamps and reflectors. The device's disinfection efficiency is up to 99%. Instruments and tools are disinfected of germs, bacteria, viruses and fungi. In consideration of health and safety, the device automatically shuts down when the cover is opened.

Features :

- 45L Capacity
- Effective sterilization using two built-in 254 nm UV lamps
- Adjustable UV light timer for convenient use
- Easy-to-clean, stainless steel racks (Grade 304)
- Interlocking safety system shuts off
- UV light automatically while opening the door

Specifications

- Power: 20W
- UV Wavelength: 254 nm
- Timer: Maximum 30 Minutes
- Overall Dimensions: 467 x 400 x 400 mm (l x w x h)
- Interior Dimensions: 360 x 360 x 360 mm (l x w x h)

Cat No.	Pack Size
CH12040S	1



UV Sanitization Chamber

UV Sanitizer Chamber is made up of heavy gauge steel for durability with enamel finish. It can be used in the Laboratories, Hospitals and Home for material sanitization; can be suitable for desktop or wall mounting.

- A high power 25W UV C lamp is used to kill germs
- It has 6 shelves which are adjusted
- The sanitizer comes with safety feature that will prevent the UV light from operating unless the doors are closed and latched properly
- The cabinet is also designed to prevent any leakage during of UV rays during operation and comes with a filtered viewing lens hole so that the user can check the operations while in use
- The dimension of the UV Chamber is 66 x 73.6 x 25.4 cm (L x H x D)

All components used are UL approved.

Cat No.	Pack Size
CH12040	1



QR - CODED Volumetric Glassware

A smart way to access calibration certificate

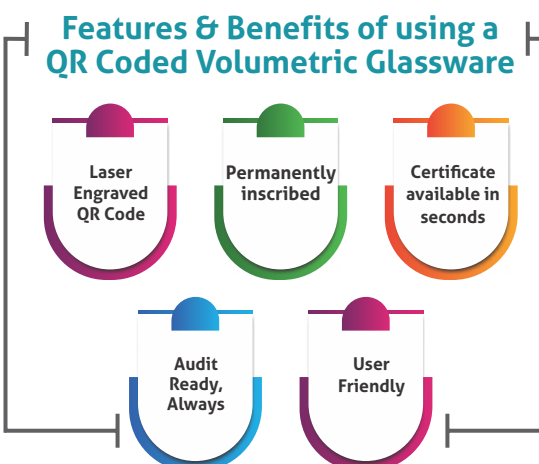

Plasticware



Dedicated towards betterment

Beakers

Polypropylene, have excellent clarity and good chemical resistance, raised graduation on outer surface. With spout.

Cat No.	Capacity, ml	Pack Size
CH10155/2	25	12
CH10155/1	50	12
CH10155/3	100	12
CH10155/7	250	12
CH10155/9	500	12
CH10155/11	1000	6
CH10155/13	2000	6



Beaker Set

Available in polypropylene/polycarbonate, these beakers are with screen printed graduation. Set of five beakers (one each of 50,100,250,500 and 1000 ml)

Cat No.	Type	Pack Size
CH10160	Polypropylene	1
CH10162	Polycarbonate	1



Beaker

Printed Graduation, Stackable

Material : PP conforming to US FDA 221 CFR Autoclavable

Cat No.	Capacity ml.	Length, mm	Diam., mm	Pack Size
CH10163/1	50	60	50	12
CH10163/2	100	72	62.5	12
CH10163/3	250	93	82.5	12
CH10163/4	500	128	110	12
CH10163/5	1000	149	129	6



Beaker

Printed Graduation, Stackable

Material : PMP (TPX) conforming to US FDA 221 CFR Autoclavable

Cat No.	Capacity ml.	Length, mm	Diam., mm	Pack Size
CH10164/1	50	60	50	12
CH10164/2	100	72	62.5	12
CH10164/3	250	93	82.5	12
CH10164/4	500	128	110	6
CH10164/5	1000	149	129	4



Beakers, With Handle (Measuring Jugs)

Polypropylene, autoclavable and have non-drip spout. These jugs have raised graduations, provide excellent contact clarity and are provided with excellent thumb grip on handle.

Cat. No.	Capacity, ml	Pack Size
CH10165/1	500	12
CH10165/3	1000	6
CH10165/5	2000	6
CH10165/7	3000	6
CH10165/9	5000	2



Reagent Bottle Narrow Mouth

Rigid, translucent & break resistant

100% leak proof and ideal for transporting liquid samples suitable for foodstuff

Material : HDPE

Cat No.	Capacity, ml	Pack Size
CH10238/1	4	72
CH10238/2	8	72
CH10238/3	15	72
CH10238/4	30	72
CH10238/5	60	72
CH10238/6	125	72
CH10238/7	250	72
CH10238/8	500	48



Reagent Bottle Narrow Mouth

Rigid, translucent & break resistant

100% leak proof and ideal for transporting liquid samples suitable for foodstuff

Material : LDPE

Cat No.	Capacity, ml	Pack Size
CH10240/1	8	72
CH10240/2	15	72
CH10240/3	30	72
CH10240/4	60	72
CH10240/5	125	72
CH10240/6	250	72
CH10240/7	500	48



Reagent Bottle Narrow Mouth

Rigid, translucent & break resistant

100% leak proof and ideal for transporting liquid samples suitable for foodstuff

Material : HDPE Amber

Cat No.	Capacity, ml	Pack Size
CH10242/1	4	72
CH10242/2	8	72
CH10242/3	15	72
CH10242/4	30	72
CH10242/5	60	72
CH10242/6	125	72
CH10242/7	250	72
CH10242/8	500	48



Reagent Bottle Narrow Mouth

PP screw cap and long neck thread ensures 100 % leakproof closure which makes it ideal for transporting liquid samples suitable for foodstuff

Material : Polypropylene

Autoclavable

Cat No.	Capacity, ml	Pack Size
CH10250A/1	4	72
CH10250A/2	8	72
CH10250A/3	15	72
CH10250A/4	30	72
CH10250A/5	60	72
CH10250A/6	125	72
CH10250A/7	250	72
CH10250A/8	500	48

Reagent Bottle Wide Mouth

Rigid, translucent & break resistant
100% leak proof and ideal for transporting liquid samples suitable for foodstuff

Material : HDPE

Cat No	Capacity, ml	Pack Size
CH10244/1	30	72
CH10244/2	60	72
CH10244/3	125	72
CH10244/4	250	72
CH10244/5	500	48

Reagent Bottle Wide Mouth

Rigid, translucent & break resistant
100% leakproof and ideal for transporting liquid samples suitable for foodstuff

Material : LDPE

Cat No	Capacity, ml	Pack Size
CH10246/1	30	72
CH10246/2	60	72
CH10246/3	125	72
CH10246/4	250	72
CH10246/5	500	48

Reagent Bottle Wide Mouth

Rigid, translucent & break resistant
100% leakproof and ideal for transporting liquid samples suitable for foodstuff

Material : HDPE Amber

Cat No	Capacity, ml	Pack Size
CH10248/1	30	72
CH10248/2	60	72
CH10248/3	125	72
CH10248/4	250	72
CH10248/5	500	48



Reagent Bottle Wide Mouth

Wide mouth heavy wall bottle
pp screw cap and long neck thread ensures 100 % leakproof closure
which makes it ideal for transporting liquid samples
wide mouth for easy filling and emptying liquid or powder samples
suitable for foodstuff
Material : Polypropylene

Cat No	Capacity, ml	Pack Size
CH10252A/1	30	72
CH10252A/2	60	72
CH10252A/3	125	72
CH10252A/4	250	72
CH10252A/5	500	48



Wash Bottles

Low Density polyethylene squeeze bottle with jet through screw cap

Cat. No.	Capacity, ml	Pack Size
CH10275/3	250	12
CH10275/5	500	6



Flask, Conical, Polypropylene

These cone shaped flasks are rigid, translucent and autoclavable. The screw cap keeps the contents of the flask contamination free and makes the flask leakproof. Threads should be disengaged before autoclaving.

Cat. No.	Capacity ml	Pack Size
CH11080/1	100	12
CH11080/2	250	12
CH11080/3	500	12



Flask Support, Polypropylene

For round bottom flasks up to 10 litres, Autoclavable.

Cat No	Pack Size
CH11076	6



Burette, Acrylic

Transparent acrylic body and a leakproof stopcock fitted with a self lubricating PTFE plug. Each Burette is individually calibrated to give maximum accuracy. Acrylic body is unaffected by dilute mineral acids and bases except Hydrofluoric Acid and Ammonium Hydroxide.

Cat. No.	Capacity, ml	Pack Size
CH10500/1	25	10
CH10500/3	50	10
CH10500/5	100	10

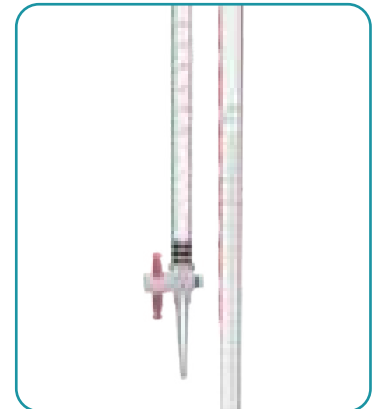

Burette Clamp

High density polythene body, non-corrosive, unbreakable, easy to fit burette, graduation can be seen clearly along its entire length.

Cat. No.		Pack Size
CH10550/1	For One Burette	12
CH10550/2	For Two Burettes	6



Cylinder Measuring, Hexagonal

The hexagonal base provides excellent stability to the cylinder where as the tapered spout works well while pouring any reagent.

Polypropylene.

Cat. No.	Capacity, ml	Pack Size
CH10815/1	10	24
CH10815/2	25	12
CH10815/3	50	12
CH10815/5	100	12
CH10815/6	250	6
CH10815/9	500	4
CH10815/10	1000	3



Polymethylpentene (PMP) Class A

Class A : Printed in Red with Calibration Certificate

Meets accuracy requirements of Class A & B under DIN 12681/ ISO 6706

Cat No	Capacity, ml	Sub Division, ml	Error Limit, ml	Pack Size
CH10819D/1	10	0.2	± 0.1	1
CH10819D/2	25	0.5	± 0.25	1
CH10819D/3	50	1	± 0.5	1
CH10819D/4	100	1	± 0.5	1
CH10819D/5	250	2	± 1	1
CH10819D/6	500	5	± 2.5	1
CH10819D/7	1000	10	± 5	1

Polymethylpentene (PMP) Class B

Class B : Printed in Blue

Cat No	Capacity, ml	Sub Division, ml	Error Limit, ml	Pack Size
CH10819BD/1	10	0.2	±0.2	12
CH10819BD/2	25	0.5	±0.5	12
CH10819BD/3	50	1	±1	12
CH10819BD/4	100	1	±1	6
CH10819BD/5	250	2	±2	6
CH10819BD/6	500	5	±5	3
CH10819BD/7	1000	10	±10	3

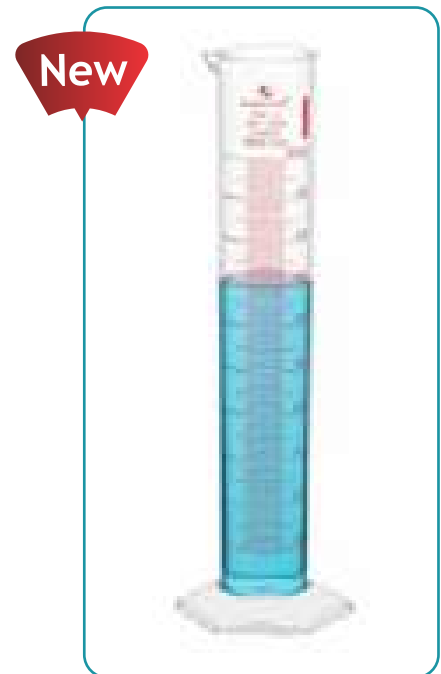

Measuring Cylinder

- Hexagonal Base for improved stability
- Generous pour out for smooth flow of liquid
- Easy to read graduation of neatly printed
- Transparent & graduated with excellent clarity
- Autoclavable

Polypropylene, Class B

Printed in Blue

Meets accuracy requirements of Class B under DIN 12681/ ISO 6706

Cat No.	Capacity, ml	Sub Division, ml	Error Limit, ml	Pack Size
CH10819AD/1	10	0.2	± 0.2	12
CH10819AD/2	25	0.5	± 0.5	12
CH10819AD/3	50	1	± 1	12
CH10819AD/4	100	1	± 1	6
CH10819AD/5	250	2	± 2	6
CH10819AD/6	500	5	± 5	3
CH10819AD/7	1000	10	± 10	3



PMP Volumetric Flask with PP Stoppers

Light in weight, these flasks are an excellent break-resistant alternative to glass and come with the newly designed **Supertek** stopper. Offers excellent chemical resistance and is completely leak proof.

PMP Class A

Cat No	Capacity, ml	Tolerance \pm ml	Neck Size (NS)	Pack Size
CH11077AD/1	25	0.04	10/19	1
CH11077AD/2	50	0.06	12/21	1
CH11077AD/3	100	0.10	14/23	1
CH11077AD/4	250	0.15	19/26	1
CH11077AD/5	500	0.25	19/26	1
CH11077AD/6	1000	0.40	24/29	1

PMP Class B

Cat No	Capacity, ml	Tolerance \pm ml	Neck Size (NS)	Pack Size
CH11077BD/1	25	0.08	10/19	1
CH11077BD/2	50	0.12	12/21	1
CH11077BD/3	100	0.20	14/23	1
CH11077BD/4	250	0.30	19/26	1
CH11077BD/5	500	0.50	19/26	1
CH11077BD/6	1000	0.80	24/29	1



PP Volumetric Flask with PP Stoppers

Light in weight, these flasks are an excellent break-resistant alternative to glass and come with the newly designed Supertek stopper. Offers excellent chemical resistance and is completely leak proof.

PP Class A

Cat. No.	Capacity, ml	Tolerance \pm ml	Neck Size (NS)	Pack Size
CH11077DD/1	25	0.04	10/19	1
CH11077DD/2	50	0.06	12/21	1
CH11077DD/3	100	0.10	14/23	1
CH11077DD/4	250	0.15	19/26	1
CH11077DD/5	500	0.25	19/26	1
CH11077DD/6	1000	0.40	24/29	1

PP Class B

Cat. No.	Capacity, ml	Tolerance \pm ml	Neck Size (NS)	Pack Size
CH11077CD/1	25	0.08	10/19	6
CH11077CD/2	50	0.12	12/21	6
CH11077CD/3	100	0.20	14/23	6
CH11077CD/4	250	0.30	19/26	3
CH11077CD/5	500	0.50	19/26	3
CH11077CD/6	1000	0.80	24/29	2



Analytical Funnel

Designed specifically for analytical chemistry, the body of the funnel is 60°. Moulded in PP, these funnels are provided with internal & external ribs to prevent air blockage.

Cat No	Size, mm	Pack Size
CH11089/10	35	72
CH11089/1	50	72
CH11089/2	62	36
CH11089/3	75	36
CH11089/4	100	36



Powder Funnels

These polypropylene funnels are best suited for transfer ring powdered reagents. The unique feature of these funnels is its parallel stem that minimizes bridging of powder. These funnels are 0 steam autoclavable at 121° C.

Cat No	Size, mm	Pack Size
CH11091/1	65	36
CH11091/2	80	36
CH11091/3	100	36



Separatory Funnel

Separatory funnel is made of polypropylene, giving it excellent contact clarity and strength. This pear shaped, autoclavable separating funnel has a leakproof threaded screw cap. The Polypropylene stopcock, fitted with a self lubricating PTFE plug, is push fitted to the stem of the separatory funnel.

Cat No	Capacity, ml	Pack Size
CH11125/1	100	2
CH11125/3	250	2
CH11125/5	500	2



Funnel Holder

Made of Polypropylene these corrosion free funnel holders can hold funnels with dia 3" to 6". The extra plate provided can be placed to hold funnels bearing dia 1" to 3". Two tapered wedges are provided to ensure firm grip on Rods having dia 1/2" or 3/8".

Cat. No.	Type	Pack Size
CH11126/1	Single	12



Separatory Funnel Holder

This non-corrosive Separatory Funnel Holder, moulded in Polypropylene, has a front opening which provides clear view of the solution and allows unobstructed placement of separating funnels. Two tapered wedges are provided to ensure firm grip on Rods having dia 1/2" or 3/8".

Cat. No.	Pack Size
CH11127	12



Pipette Pump

A fast release pipetting device for precise pipetting & zip quick emptying. The Knurled thumbwheel can be rotated to draw up or dispense liquids while the releaser may be pushed in for zip - quick emptying. The moulded chuck has a silicon rubber collet inside to hold various pipettes of standard sizes. It resists acids and alkalies and can be easily disassembled for thorough cleaning.

Cat No.	Size, ml	Pack Size
CH11815/1	2	12
CH11815/4	10	12
CH11815/5	25	12



Pasteur Pipette, Non-Sterile

- Non-toxic & unbreakable
- Made from LDPE
- Uniform Wall Thickness
- Low affinity
- Low binding surface

Cat No.	Capacity, ml	Pack Size
CH11622/1	1	500
CH11622/3	3	500



Pipette Stand

To Hold 12 Pipettes Horizontally.

Cat. No.	Pack Size
CH11850	6



Spatula

Moulded in Polypropylene, Spatula consists of a spoon on one side while the other end is a flat construction with a knife edge. This edge is helpful in breaking up crystals of different salts while the spoons used to draw salts from the containers.

Cat No.	Size, mm	Pack Size
CH12210/1	150	12
CH12210/2	200	12

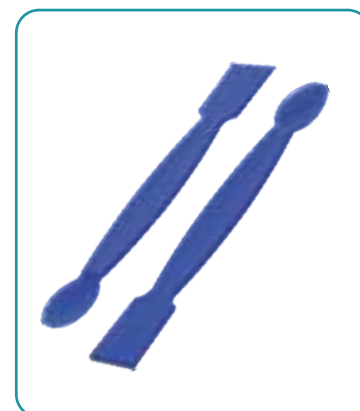

Policemen Stirring Rods

This, in fact, is a multipurpose apparatus which works as a stirrer as well spatula. The fattened ends of this rod form two small spatulas.

Cat No.	Size mm	Pack Size
CH12390	ø-6 mm x h-245 mm	12



Pipette Stand

To Hold 24 Pipette Vertically. Plastic.

Cat. No.	Pack Size
CH11855/1	1



Pipette Stand (94 Pipettes Rotary)

Polypropylene holds a maximum of 94 pipettes and rotates on a central vertical axis for convenient selection of any particular pipette. The lower rotating disc has four concentric troughs with tapered sides and open bottoms which cradle the pipette tips protectively and permit water drops to run off. The upper disc has a grid pattern concentric with the bottom discs and keeps the pipettes vertical. Liquids draining off the pipettes are retained on the top of the stationary base by the outer ring. This stand can be easily disassembled & reassembled.

Cat No	Pack Size
CH11860	1



Test Tube Stand (3 Tier)

3 tier design provide clear view of the tube contents and convenient insertions and removal of tubes. These autoclavable racks can withstand sub-freezing temperatures.

Polypropylene Cat No.	Size	Pack Size
CH12765/1	13 mm x 31 Tubes	2
CH12765/2	16 mm x 31 Tubes	2
CH12765/3	20 mm x 20 Tubes	2
CH12765/4	25 mm x 12 Tubes	2
CH12765/5	25 mm x 18 Tubes	2
CH12765/6	32 mm x 12 Tubes	2
CH12765/8	25 mm x 36 Tubes	2
CH12765/9	13 mm x 18 Tubes	4
CH12765/10	15 mm x 18 Tubes	4
CH12765/12	18 mm x 12 Tubes	4
CH12765/13	13 mm x 62 Tubes	2
CH12765/14	16 mm x 62 Tubes	2
CH12765/15	20 mm x 40 Tubes	2

Test Tube Stand (3 Tier)

Polycarbonate Cat No.	Size	Pack Size
CH12770/1	13 mm x 31 Tubes	2
CH12770/2	16 mm x 31 Tubes	2
CH12770/3	20 mm x 20 Tubes	2
CH12770/4	25 mm x 12 Tubes	2
CH12770/8	13 mm x 62 Tubes	2
CH12770/12	16 mm x 62 Tubes	2
CH12770/15	20 mm x 40 Tubes	2
CH12770/16	25 mm x 24 Tubes	2
CH12770/17	25 mm x 18 Tubes	2
CH12770/18	25 mm x 36 Tubes	2
CH12770/19	32 mm x 12 Tubes	2

Test Tube Stand

Polypropylene, autoclavable, available in two sizes, with drying pins.

Cat No.	Size	Pack Size
CH12755/2	16 mm & 25 mm Ø Tubes	12
CH12755/3	25 mm Ø Tubes	12

Thermometer Rack

Cat No.	Item Description	Pack Size
CH12920	Thermometer Rack	1



Laboratory Tray

Needless to say, Polypropylene laboratory Tray moulded in Polypropylene is a multipurpose tray that can be used for sterilizing, drying glassware porcelainware & other laboratory instruments. These steam autoclavable trays have tapered walls which prove good for nesting.

Cat No	Size	Pack Size
CH11862/1	450mm x 350mm x 75 mm	2
CH11862/3	375mm x 300mm x 75 mm	2



Utility Tray

Adding to the already existing range of autoclavable laboratory trays, is the utility Tray and as the name suggests this Polypropylene Tray can be utilized for purposes ranging from drying glassware to sterilizing and to store and laboratory apparatus.

Cat. No	Size	Pack size
CH11864	375mm x 350mm x 130mm	2



Instrument Tray

This autoclavable trays have cover which fits into groove of trays to minimize spillage of material .Smaller size can be used to sterilize small instrument whereas the larger size allows pipettes to be fully immersed in disinfectant prior to ste rilizing .

Cat No	Size	Pack Size
CH11868/1	220mm x 150mm x 70 mm	2
CH11868/2	450mm x 150mm x 70 mm	2



Test Tube Baskets

Test Tube Baskets are made of Polypropylene. These autoclavable, Unbreakable and non-corrosive Baskets are ideal for rinsing & draining glassware. These are also useful for storage of test tubes or culture tubes during sterilization or incubation.

Cat No	Size	Pack Size
CH12777/1	140 mm x 120 mm x 110 mm	2
CH12777/2	160 mm x 160 mm x 160 mm	2



Container, Stool

In addition to the range of existing sample containers, this Stool Container has the unique feature of one piece moulded cap-spoon combination.

Cat No	Capacity, ml	Pack Size
CON10007	25	100



Rack For Petri Dishes

Clear acrylic with polycarbonate posts. Useful during inoculation, incubation & storage. Visibility from all sides enables the culture to be seen and check during incubation.

Cat No	Size	Pack Size
CH10935/1	Rack for 90 mm petri dishes	2
CH10935/3	Rack for 60 mm petri dishes	2



Microscope Slide Box

Slide storage boxes are designed for the safe long term storage of microscope slides. These storage boxes accommodate standard 25 x 75 mm / 1 x 3" microscope slides.

- Made of Durable High Quality ABS Plastic.
- Heavy walls will not warp, splinter or crack.
- Cork sheet lined base for safe storage.
- Boxes are unaffected by humidity & also are insect proof.
- Available in 4 different capacities for storage of 12/25/50/100 slides.
- An inventory sheet is located on the inside cover for convenient slide identification and organization.

Cat No	Slide	Pack Size
CH11191/11	12 Slides	24
CH11191/12	25 Slides	12
CH11191/13	50 Slides	12
CH11191/14	100 Slides	6

* Standard Color-Grey

* Also available in Blue, Grey, Black, White Colors on request.

MOQ Applicable



Physical Properties of Supertek® Plasticware

Resin	Max use Temp °C	Brittleness Temp °C	Transparency	Sterilization						Flexibility	Water Absorption%
				Autoclaving	Gas	Dry Heat	Radiation	Disinfectant	Specific Gravity		
HDPE	120	-100	Translucent	No	Yes	No	Yes	Yes	0.95	Rigid	20.01
LDPE	80	-100	Translucent	No	Yes	No	Yes	Yes	0.92	Excel	<0.01
PC	135	-135	Clear	Yes+	Yes	No	No	Yes	1.20	Rigid	0.35
PP	135	0	Translucent	Yes	Yes	No	No	Yes	0.90	Rigid	<0.02
PS	90	20	Clear	No	Yes	No	Yes	Some	1.05	Rigid	0.05

Sterilization

- Autoclaving (121°C, 15 psi for 20 minutes) Clean and rinse item with distilled water before autoclaving. Certain chemicals which have no appreciable effect on resins at room temperature may cause deterioration at autoclaving temperatures.
- **Always completely disengage threads before autoclaving.**
- Gas - Ethylene oxide formaldehyde.
- Dry heat - 160°C for 120 minutes
- Disinfectant - Benzalkonium chloride, formalin, ethanol, etc.
- Radiation - gamma irradiated at 2.5 Mrad with unstabilized plastic. Sterilizing reduces mechanical strength. Do not use PC vessels for vacuum application if they have been Autoclaved

Chemical Resistance For Supertek® Plasticware

CLASSES OF SUBSTANCES AT ROOM TEMPERATURE	HDPE	LDPE	PC	PP	PS
ACIDS, DILUTE OR WEAK	Green	Green	Green	Green	Green
ACIDS, STRONG AND CONCENTRATED	Green	Green	Red	Green	Orange
ALCOHOLS, ALIPHATIC	Green	Green	Blue	Green	Green
ALDEHYDES	Blue	Blue	Orange	Blue	Red
BASES	Green	Green	Red	Green	Green
ESTERS	Blue	Blue	Red	Blue	Red
HYDROCARBONS, ALIPHATIC	Blue	Orange	Orange	Blue	Red
HYDROCARBONS, AROMATIC	Blue	Orange	Red	Orange	Red
HYDROCARBONS, HALOGENATED	Orange	Red	Red	Orange	Red
KETONES	Blue	Blue	Red	Blue	Red
OXIDIZING AGENTS, STRONG	Orange	Orange	Red	Orange	Red

 30 Days of constant exposure cause no damage. Plastics may even tolerate for years.

 Little or no damage after 30 days of constant exposure to the reagents.

 Some effect after 7 days of constant exposure to the reagent like crazing, cracking, loss of strength or discolouration.

 Not recommended for continuous use. Immediate damage may occur.

A

Absorption Columns	67
Adapters	
Cone Screw Thread	55
Cone To Flexible Tubing	51-52
Cone With Stem To Flexible Tubing	53
Expansion	43
Multiple	44
Receiving	45-48
Reduction	43
Socket To Cone With Side Arm and Screw Thread	53
Socket To Flexible Tubing	52-53
Splash Head	49-50
Swan Neck	45
Air Leak Tube/Gas Inlet Tube	55
Alcohol Distillation Unit	126
Alcohol Burner, Wickless	160
Arsenic Determination Apparatus	128
Aspirator Bottles	117
Autoclave Digital	183

B

Basins	
Evaporating	139
Silica	140
Beakers	
Amber	70
Low Form, Tall Form	70-71
Philips	72
Low Form with Spout	136
Beakers, With Handle (Measuring Jugs) PP	190
Beaker Sets, Polypropylene/Polycarbonate	189
Blood Sugar Tubes, Folin Wu	134
Boss Head	150-151
Bottles	
BOD	116
Dropping	115
Gas Washing	118-119
Mc Cartney	114
Reagent	111-114
Reagent, N.M./W.M., PP	190-192
Roux	116
Solution	115-116
Brushes	
Beaker	167
Bottle	167
Burette	167

Alphabetical Index

Flask	168
Pipette	168
Semi Micro Test Tubes	168
Test Tube	168
Burette Clamps	148,193
Burettes	1-9
Amber	4,6
Automatic Zero	7-9
Glass Key Stopcock	2,6
PTFE Needle Valve (Rotaflo)	3
PTFE Key Stopcock	5
Burette, Acrylic	193
Burners	
Bunsen	158-159
Methylated Spirit	160
Tirrill	159
With Flame Stabilizer	158
Burner Tube	162
C	
Caps, PP Screw Cap	114
Centrifuge Tubes	
Conical Bottom	133-134
With Screw Cap	134
Chromatography Columns	67-68
Claisen Head	49
Clamps	
3 Prong	149
Burette	148,193
Extension Universal	150
Metal, Die Cast	148
Rings With Clamps	150
Sheet Metal	148
Universal Clamp	149
Clamp Holder (Boss Head)	151
Clevenger Apparatus	123-124
Combustion Boats	
Porcelain	139
Quartz	137
Condensers	
Air	58
Allihn (Bulb Condenser)	63
Coil, Graham	60
Coil, Reversible	61
Double Coil, With Common Inlet	61
Double Surface, Davies	62
Ether	64
Friedrich	64

Immersion (Cold Finger)	64	Conical, (Erlenmeyer) With Screw Cap	88
Inland Revenue	63	Conical, Polypropylene	192
Jacketed Coil, Double Surface Condenser	62	Conical, With Interchangeable Stopper	89
Liebig	59	Culture, Haffkine	90
Cone Single/ Double	38-39	Dissolution	91-92
Cones, Imhoff	36	Distillation	78
Conical Filter, (Hirsch Type)	104	Erlenmeyer, Conical, Long Neck	76
Conical Flask	136	Evaporating, Florentine	87
Container, Stool	201	Filter Bolt Neck	78
Crucibles		Flat Bottom	73
Gooch	103	Flat Bottom, Single Neck	80
Silica	140	Flat Bottom, Wide Neck	73
Without Lid	137	Iodine	89
Crucible Tongs	153-154	Kjeldahl, Long Neck	76-77
Culture Tubes	131-132	Pear Shape	87
D		Reaction	90
Desiccators	99	Round Bottom	74-75
Dish, Crystallizing	99-100	Round Bottom, Single Neck	79
Dissecting Forceps	155	Round Bottom, Two Necks	81-82
Distillation Apparatus	124-129	Round Bottom, Three Necks	83-84
Distillation Units	141-143	Round Bottom, Four Necks	85-86
Drum Sampling Tube	20	Solvent Storage, Glass stopcock	86
Drying Tube	54	Sugar Estimation	30
E		Support, Polypropylene	193
Essential Oil Determination Apparatus (Clevenger Type)	123	Volumetric	21-30
E-Funnel	108	Volumetric, PP	195
Extension Burette Clamp	149	Forceps	156
F		Fractionating Columns	66
Fabric Heating Mantles	177	Funnels	
Filter Holders, Stainless Steel	108	Analytical	196
Filter Papers	145-146	Buchner	103-104,139
Filter Membrane	173	Dropping	97-98
Filter, Syringe	170-172	Filter	92-93
Filtration Apparatus		Powder, Polypropylene	93,196
All Glass Filtration Assembly	107	Pressure Equalizing	98
Filter Holder With Silicon Stopper	106	Funnel Holder, Polypropylene	196
Filtering Tube	105	G	
Flasks Amber, Boiling, Flat Bottom	73	Gas Generator, Kipp's	101
Amber, Conical (Erlenmeyer) Graduated	75	Gauze, Iron	160
Amber, Conical, With Interchangeable Stopper	89	Glass Spreader	101
Amber, Dissolution	92	Glass Stirring Rods	55
Amber, Flat Bottom	80	H	
Amber, Round Bottom	74,79	Hand Protectors	161
Color Coded	26	Heating Mantles, Digital	175
Conical (Erlenmeyer) Graduated	75-76	Heating Mantle With Stirrer	176
Conical, (Erlenmeyer) With Joint	88	Heating Mantle, Multi Position	178

Hot Plates	178-180
Hot Plate Magnetic Stirrer	180-181

I

Impinger, Graduated For Sampling Small Gas Volume	135
Incubator, Forced Convection	184
Instrument Tray	200

J

Jars, Rectangular, Museum	90
Joint Clips	40

K

Kjeldhal Distillation Assembly	127
--------------------------------	-----

L

Laboratory Jacks	147
Laboratory Tray	200
Lid For Crucible	137

M

Macro Kjeldahl Distillation	125
Magnetic Stirrer	182
Magnetic Stirring Bar (PTFE)	182
Mask, Surgical	169

Measuring Cylinders

Amber	33
Hexagonal Base	32-33,35
Interchangeable Glass Stopper	35
Polypropylene	193-194
Pour-out Round Base/ Hexagonal	32-34
Round Base	35
USP	33

Meker Burner	159
Microscope Slide Box	201
Milk Pipettes	19-20
Moisture Determination Apparatus	123
Mortar & Pestles	138

N

Neoprene Tubing	162
Nessler Cylinders	36

O

Oxygen Flask	77
Oven, Universal, Digital	186

P

Pasteur Pipette, Non-Sterile	197
Petri Dishes	100-101
Petri Dishes Rack, Polycarbonate	201

Pipettes

Amber	17
Amber, Graduated, Mohr Type	17
Amber, Transfer, Volumetric, USP	14-15
Automatic (Tilt Measure)	20
Dropping19Graduated, Mohr Type	16
Graduated, Serological	17-18
Pasteur	19
Transfer, Volumetric	12-15
USP	13,15,17
Pipette Bulb	161
Pipette Filler	162
Pipette Pump	197
Pipette Stand, Polypropylene	197-198
Polymethylpentene (PMP)	194
Preparation Assembly	127
Pyknometers	121-122

Q

Quartzware	136-137
------------	---------

R

R M Value Apparatus	129
Reagent Bottles	111-114
Reagent Bottle With Stopper	136
Recovery Bend	48
Reflux Assemblies	124-125
Reichert Wollney's Apparatus	127
Retort Stands	154-155
Retort Stand Ring	150
Rubber Stoppers	163-164
Rubber Tubing	162-163

S

Safety Rider for Volumetric Flask,	166
Hexagonal Shape, Silicon Rubber	166

Separating Funnels

Amber	96
Globe Shape	96
Squibb Shape	95
Separatory Funnel Holder	196-197
Silica Triangle on Nichrome	140
Silicon Rubber Cone	166
Sintered Glass Filter Tube	105
Sockets Single/ Double	38
Soxhlet Extraction Apparatus and Spares	65
Spare Rubber Bellow With Cotton	
Net for Automatic Burettes	9
Spatulas	155,198

Specific Gravity Bottles, Weld	120
Spherical Joints	39
Stand For Cones, Imhoff	36
Steam Distillation Head, Sloping	51
Still Head	49
Stirring Rods	198
Stirrers ,Teflon Bladed	56

Stoppers

Amber	41-42
Flat Head	42
Hollow, Hexagonal Head	40-41
Penny Head	41
Sterility Test Unit	109
Stoppers, Silicon Rubber	165
Sulphur Di Oxide Assembly	129
Super Stopper™	42
Syringe Filter	170-172

T

Teats For Pipettes	161
--------------------	-----

Test Tubes

Borosilicate Glass	130
Digestion, Folin-Wu	135
Flat Bottom	131
Graduated	130
With Joint & Stopper	133
With Rim	137
Test Tube Baskets	200
Test Tube Holder	156
Test Tube Stand	156
Test Tube Stands, PP	199
Test Tube Stands, Aluminium/ Stainless Steel	157
Thermometer Pocket	54
Thermometer Rack	199
Tongs	
Beaker	153-154
Crucible	153-154
Flask	154
Muffle Furnace Crucible	154
Tripod Stands	151-152
Tubing, Silicon Rubber	166

U

U Tube With Two Sockets	54
Ultrasonic Baths	185
Unstirred Water Baths, Digital	185
Utility Tray	200
UV Cabinet	186

UV Sanitization Chamber	187
-------------------------	-----

V

Vacuum Distillation	127
Vacuum Filter Holder	108
Vacuum Pumps	109

Volumetric Flasks

ASTM	28-29
Color Coded	26
NABL	22,24
Polypropylene	195
Short Neck	30
Suger Estimation	30
USP	25,27,28
Wide Mouth	27
With Special White Mark	26
Volumetric Flask with NS Stoppers, PP	195
Volumetric Flask With Stopper	136
Vortex Mixer	183

W

Wash Bottles	192
Washing Bottle, Glass and Spare Head	117-118
Watch Glass	184-185
Water Baths	184-185
Water Distillation Equipment (Cabinet Model)	143
Water Still	141
Weighing Bottles	119-120
Weighing Scoop	91

Terms And Conditions

- All correspondence should be addressed to our corporate office at following address
Shiv Dial Sud & Sons
23, Industrial Estate Ambala Cantt. 133 006
Tel: +91-171-2699297, 2699537, 2699903
Mail :- support@supertekglassware.com, info@supertekglassware.com
- Prices are net Ex-Works Ambala, subject to market fluctuations and changes without notice.
- Packing, shipping, freight and all other charges are extra. The company is not responsible for breakage or loss during transportation.
- GST or other taxes will be charged extra according to government regulations
- Product images, printed in the catalog are for reference only. Actual products may differ from the images.
- Due to constant research and development, any article can be deleted or changed without prior notice.
- All equipment listed in the catalog are installed by the user with the help of the instructions manual provided, in case of installation by a representative of the company, the cost will be charged extra and will be indicated on a case-by-case basis.
- IQ/OQ/PQ charges will be levied extra and will differ from equipment to equipment.
- supertek is registered trademark of Shiv Dial Sud & Sons. Any unauthorized use of trademark is violation law and is subject to civil and/or criminal proceedings.
- All disputes are subject to Ambala jurisdiction only.

Copyright

© 2023 Shiv Dial Sud & Sons. All rights reserved.

This publication or any part thereof (including each photograph & the text) is exclusively owned by Shiv Dial Sud & Sons. Any violation of exclusive Copyright (s) without prior written permission of Shiv Dial Sud & Sons by means of Copying or altering one or more photographs, text or visual presentation in this publication or any part thereof for any commercial purpose (including inserting any photograph or text in your own Catalogue or for advertising or sale), electronically or otherwise, can make you liable for appropriate Criminal and Civil action without issuing any prior formal or written notice to you.

Ease of Getting a Supertek Product



Our
 Authorised Distributors
 across the Country

ISO
Certified

NABL
Accredited

GMP
Certified

NSIC
Registered

CE
Certified



Contact Us

📍 23, Industrial Estate,
Ambala Cantt. 133006
(HARYANA)

☎ 0171-2699297
86075-12121

✉ support@supertekglassware.com
🌐 www.supertekglassware.com